

Universität Innsbruck

Seminar aus Rechtstheorie und Rechtsinformatik

Lücken

Friedrich Lachmayer

28. Oktober 2003

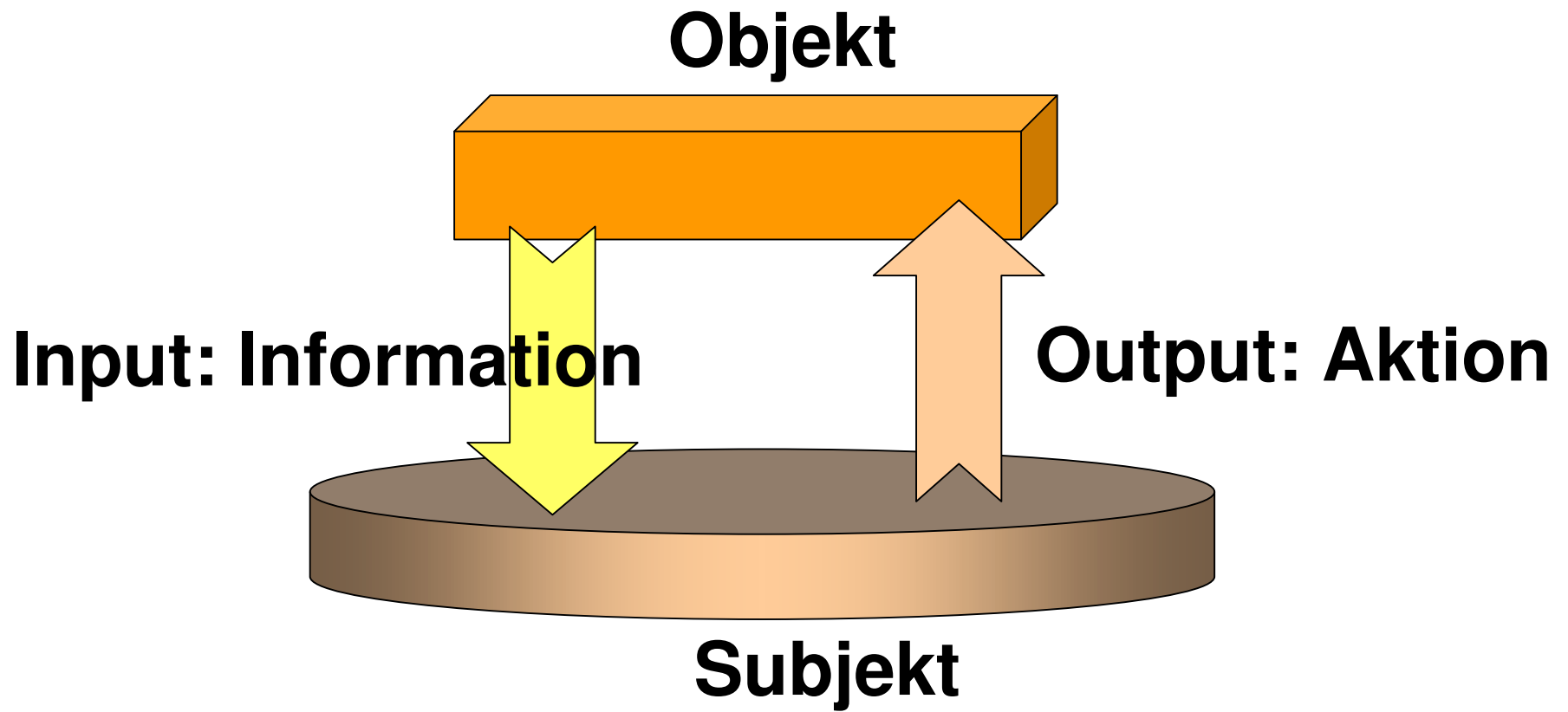

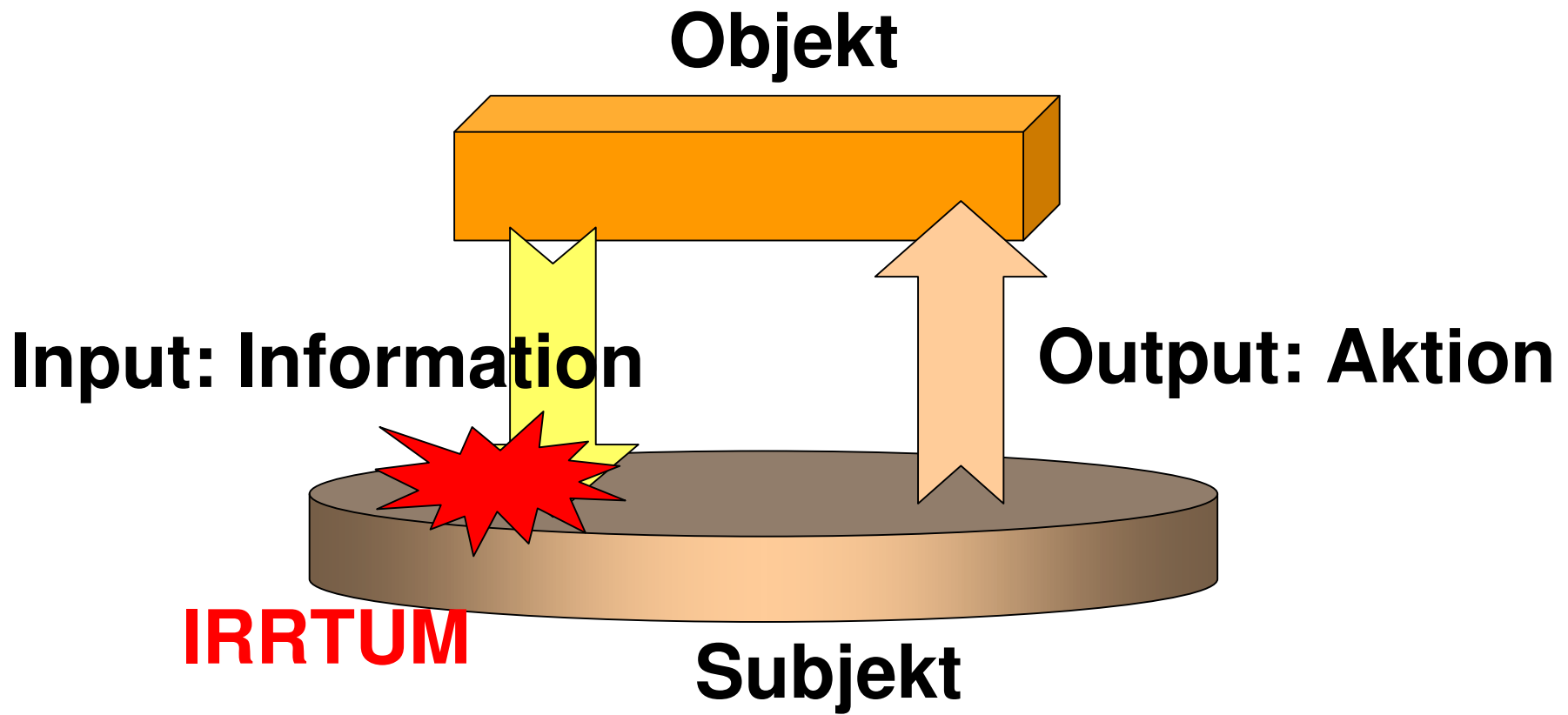

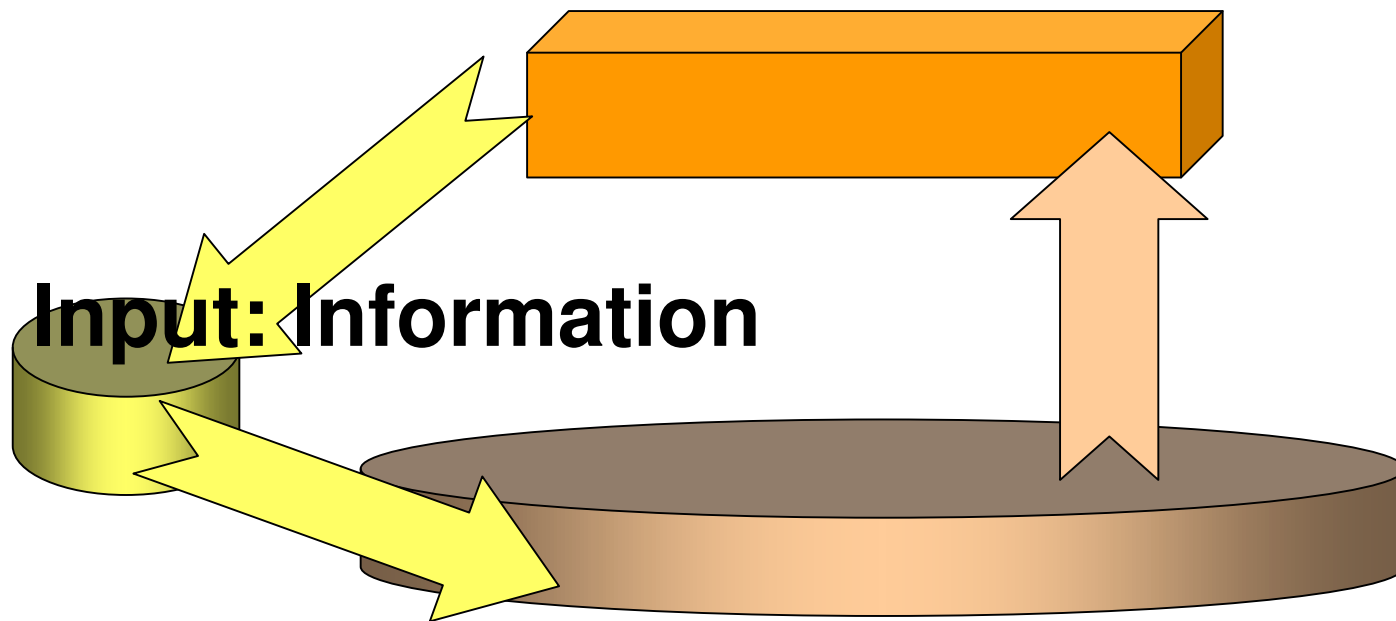

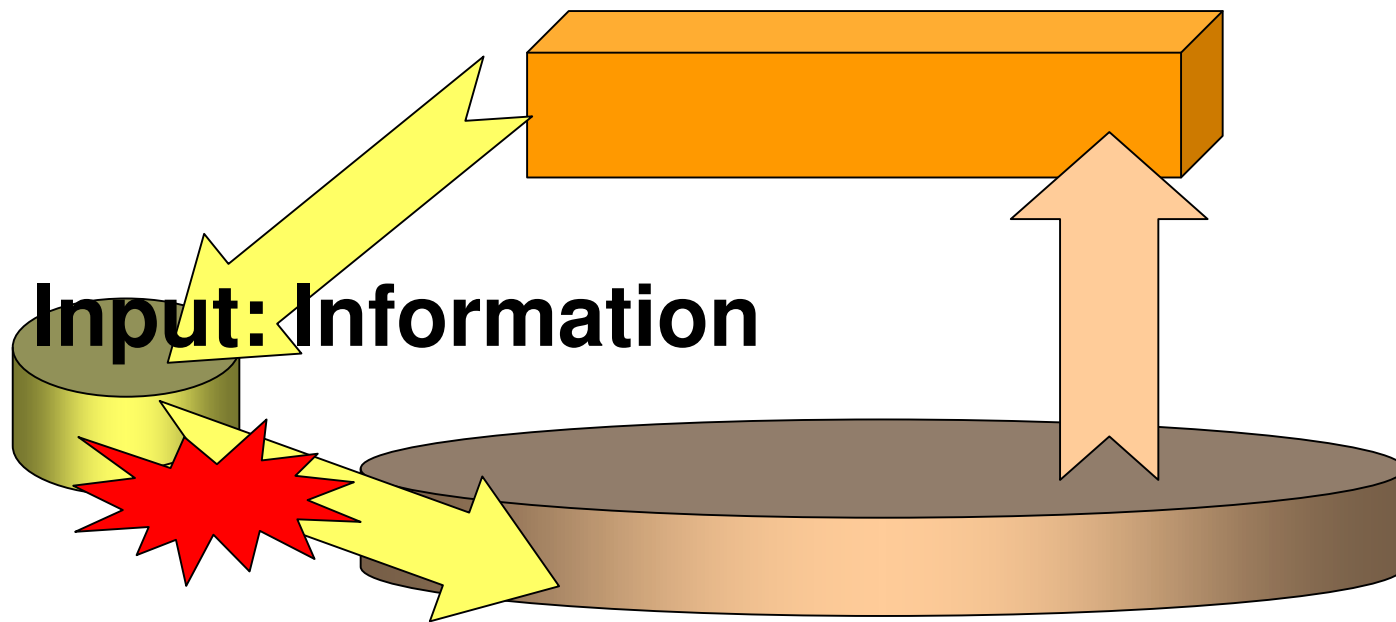

ANDERS

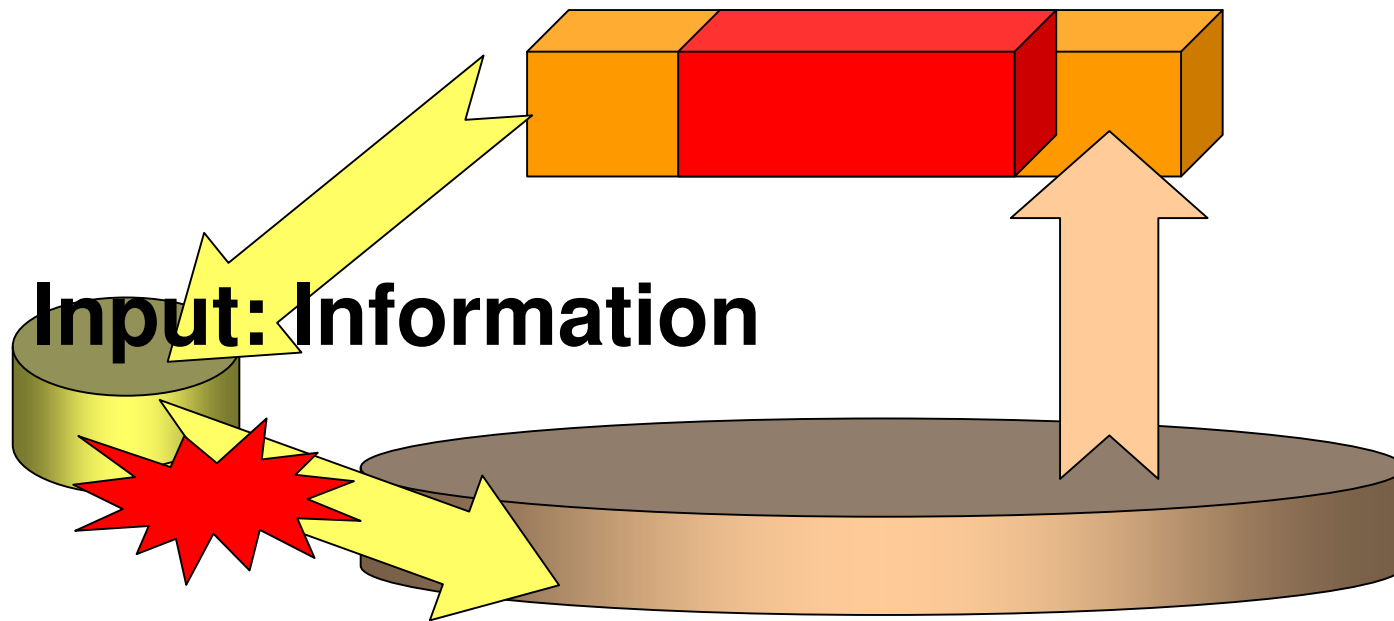

HINZUFÜGEN

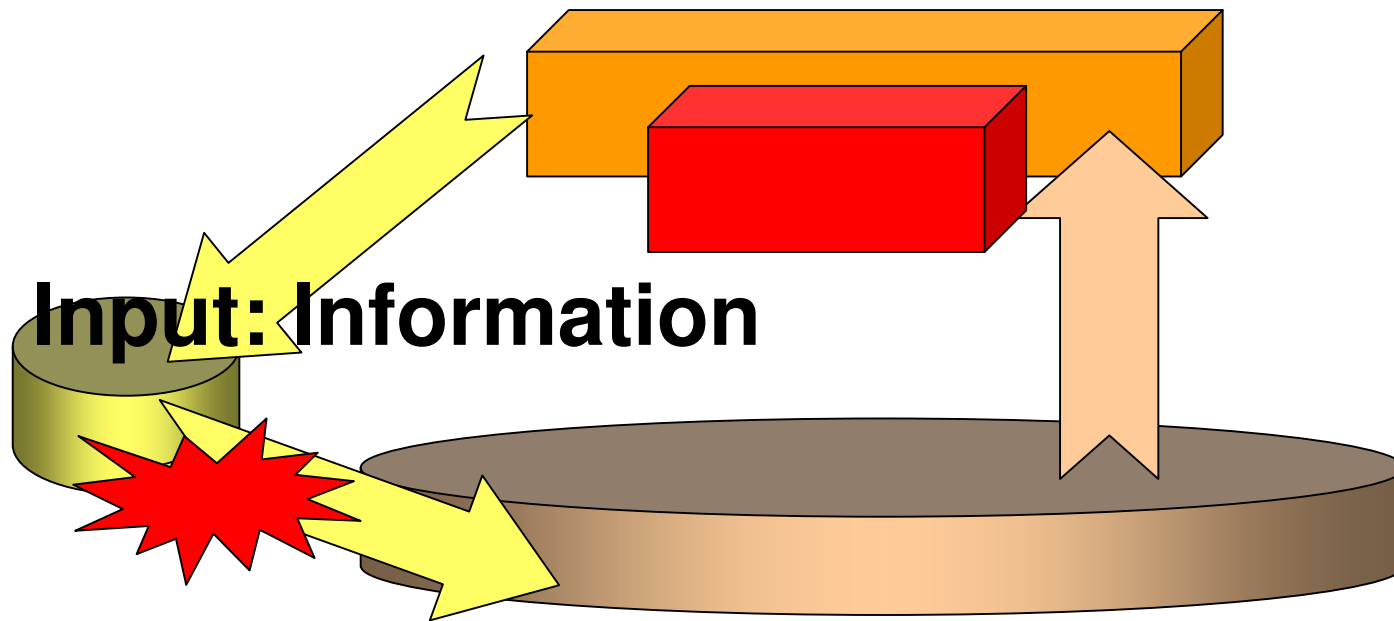

WEGLASSEN

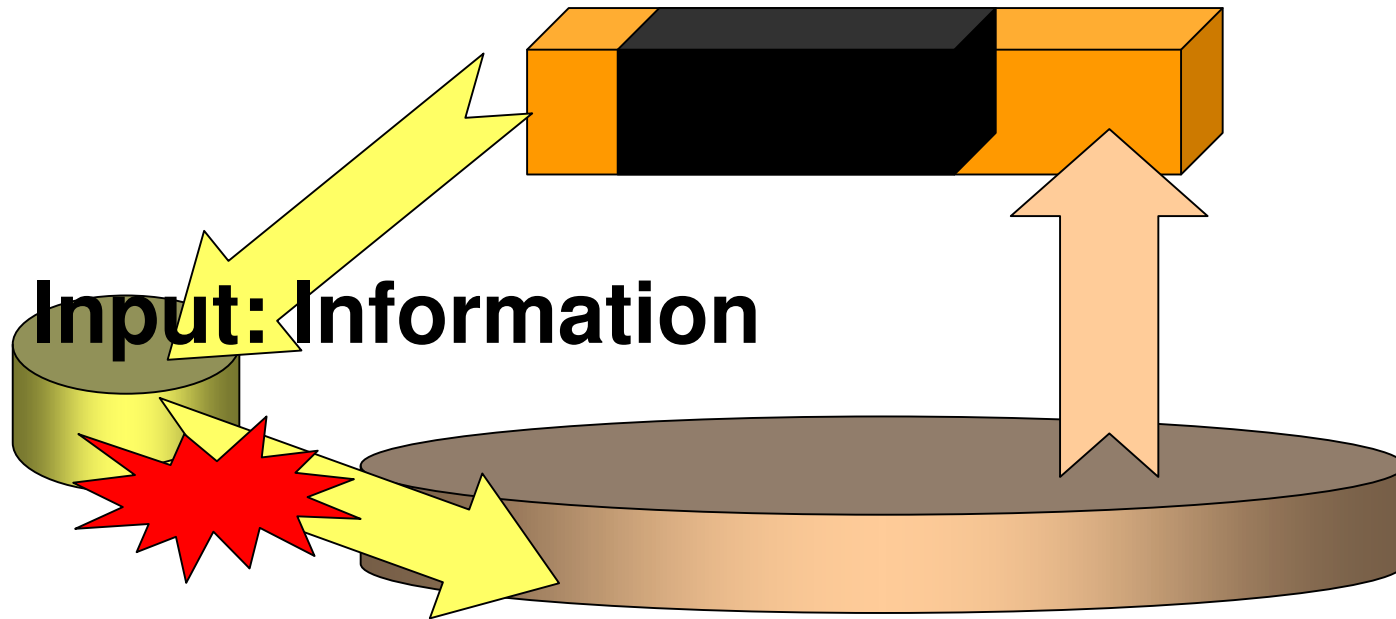

*„Wie war es bei den Türken
Münchhausen?“*

„Gewaltig!“

*„Wie war es auf der Insel
Robinson?“*

„Fad!“

Indikatoren:

Negation

„nicht“

Indikatoren:

Distanzierung

„wohl“

Indikatoren:

Verstärkung

„logisch“

Indikatoren:

Verstärkung

„logisch“

Kommt meist von „gelogen“

Kontext

**Faktum stimmt,
nicht aber der Rahmen**

Deutungen

**Sind meist raffinierter
als**

Tatsacheninformationen

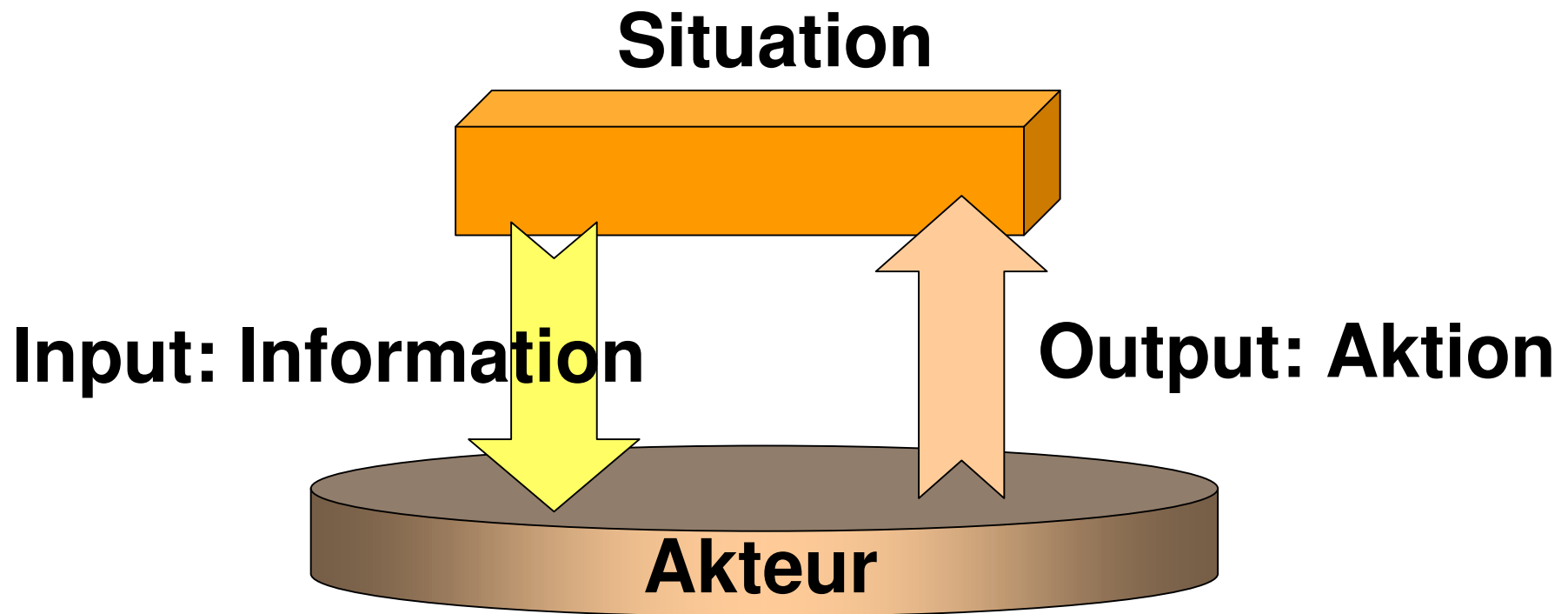

Situation

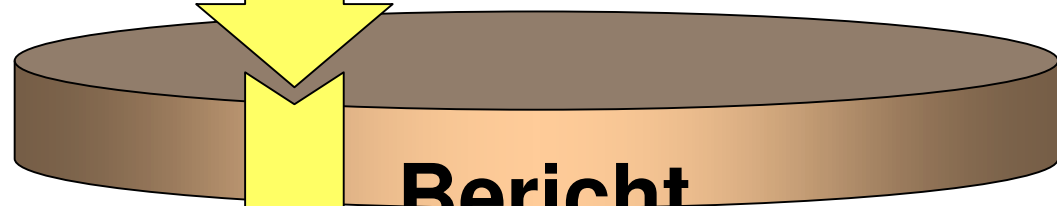

Bericht

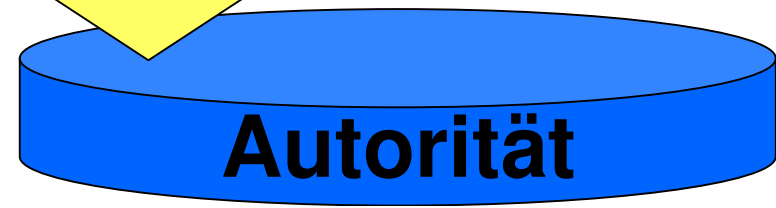

Autorität

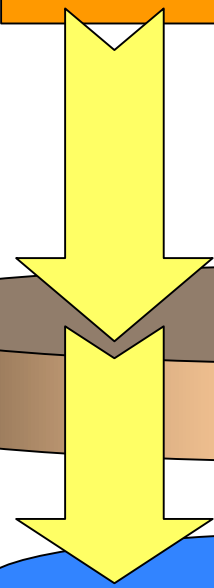

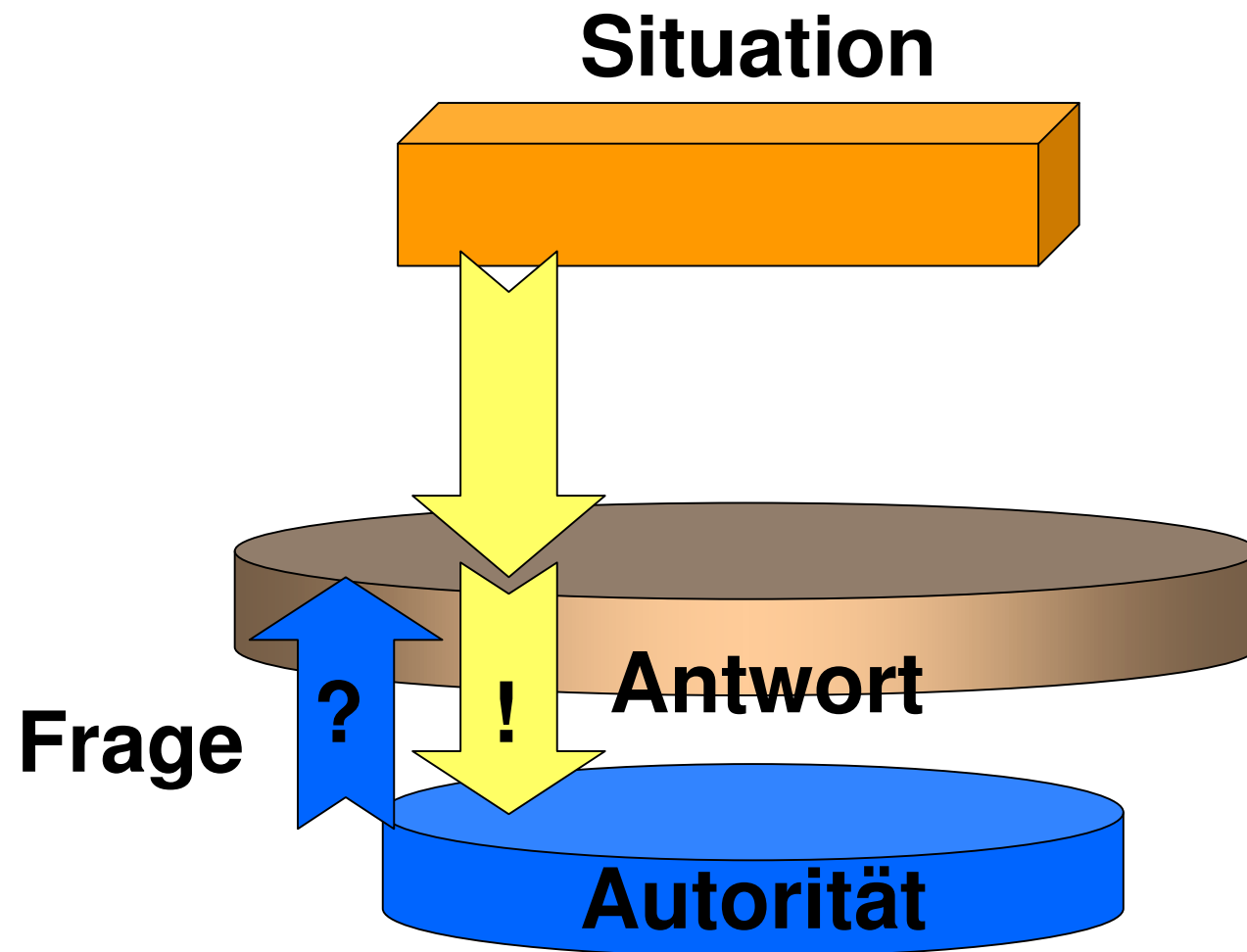

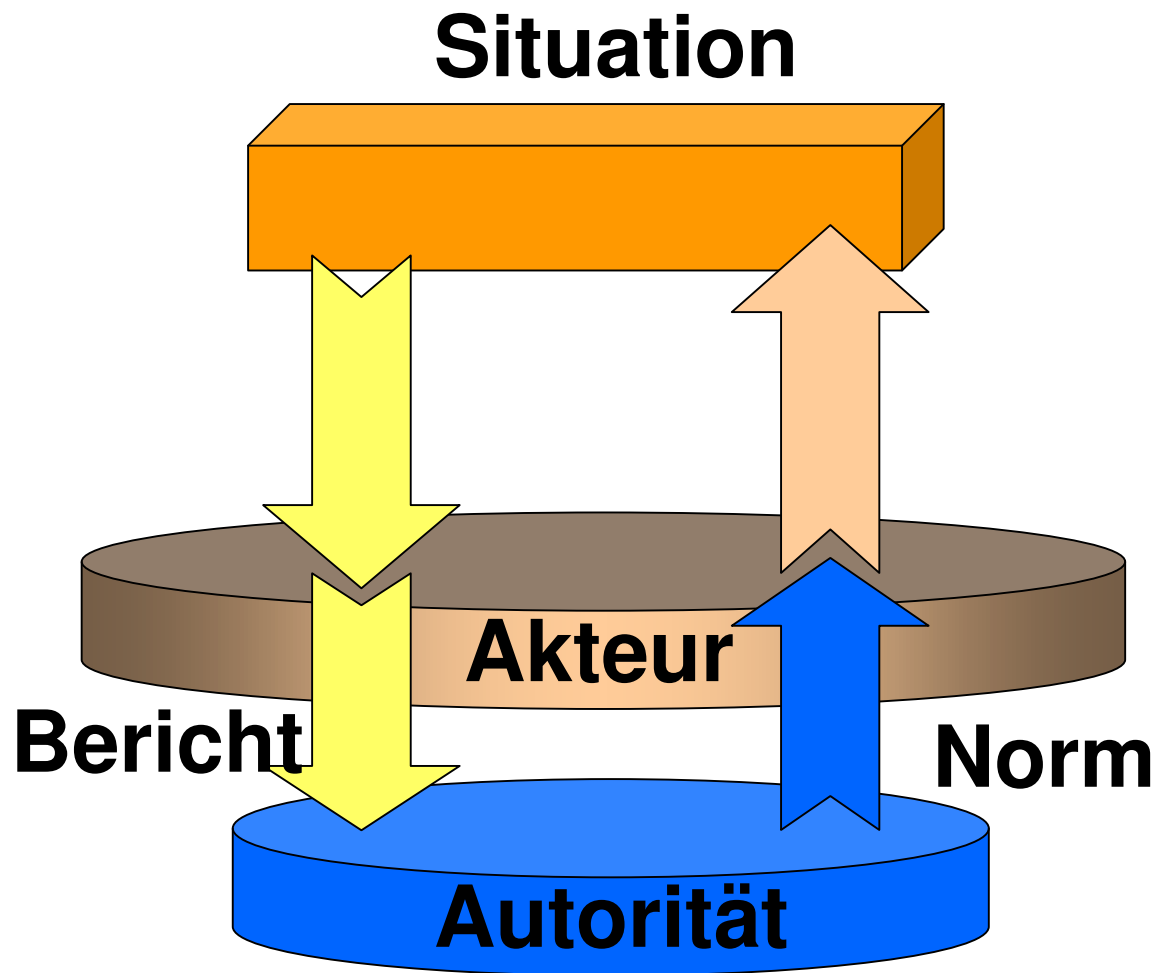

Situation

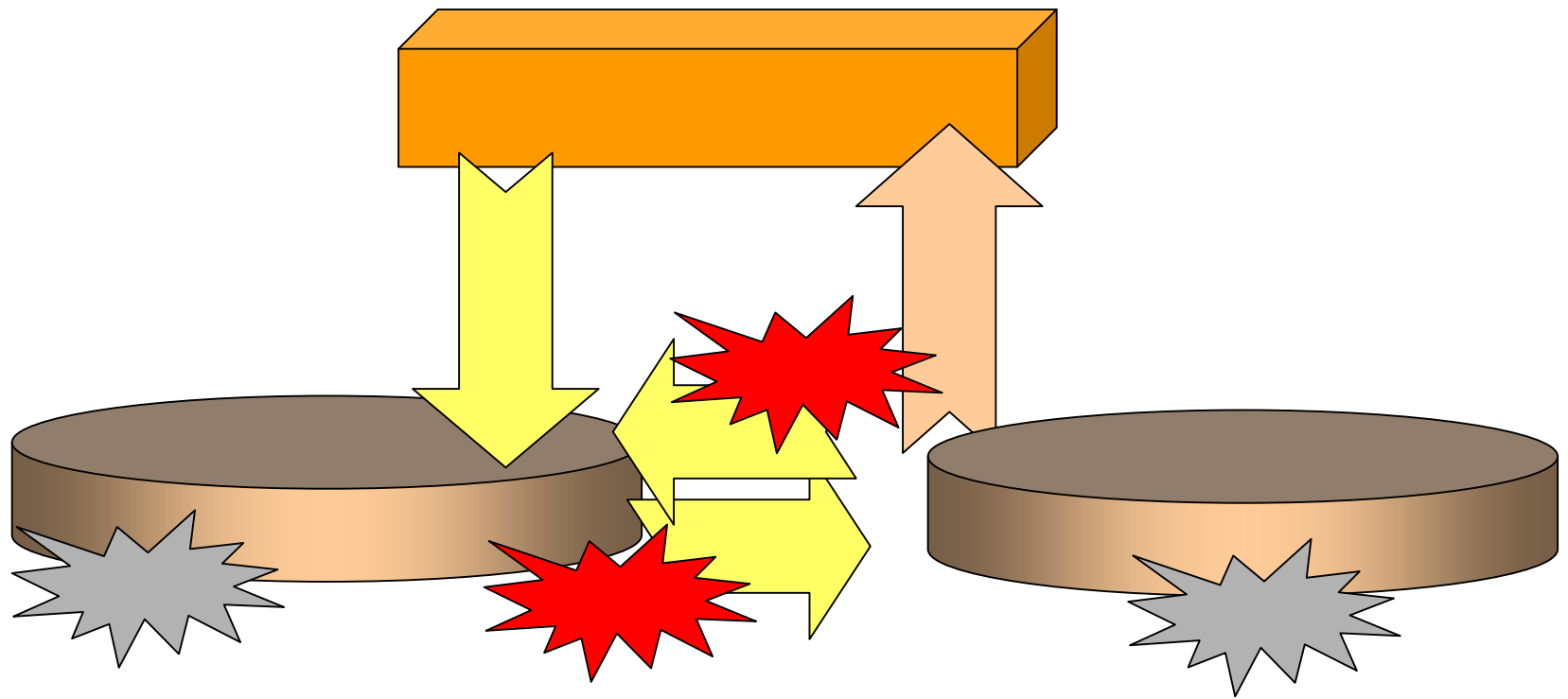

„Situation“

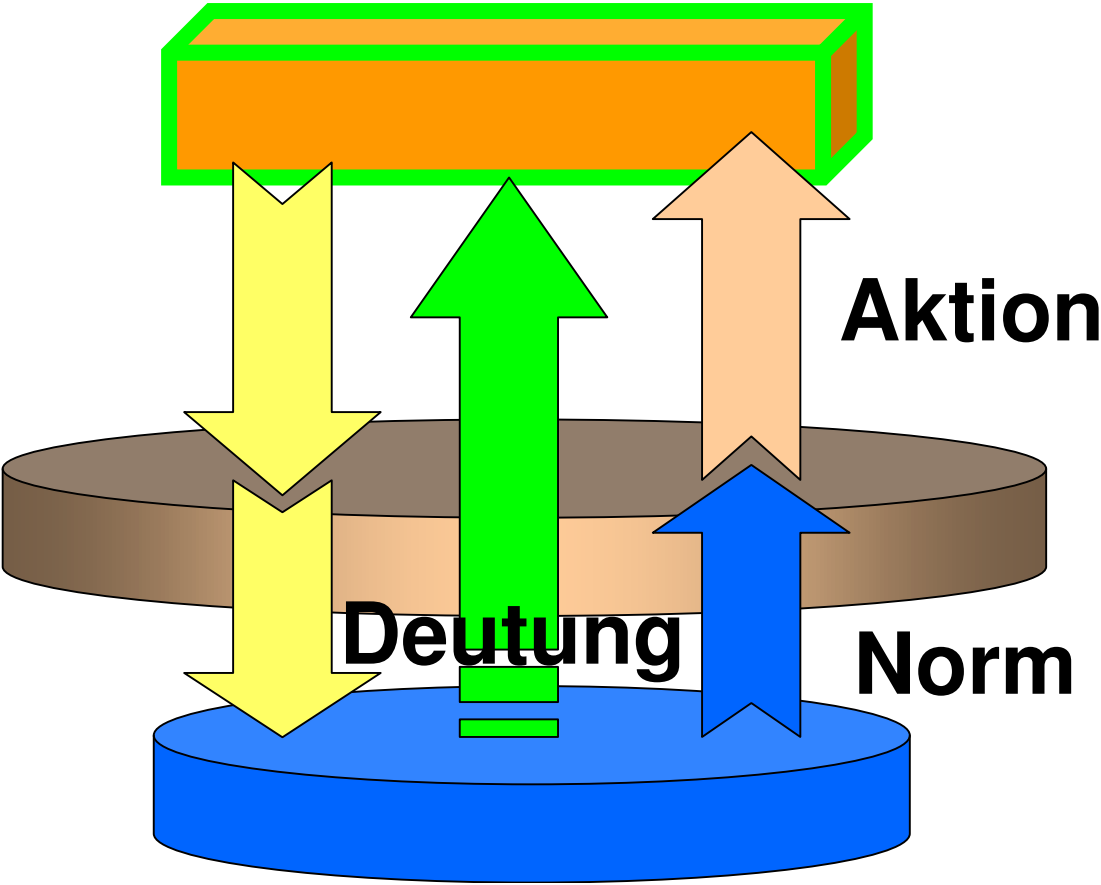

REKONSTRUKTIONSMODELLE

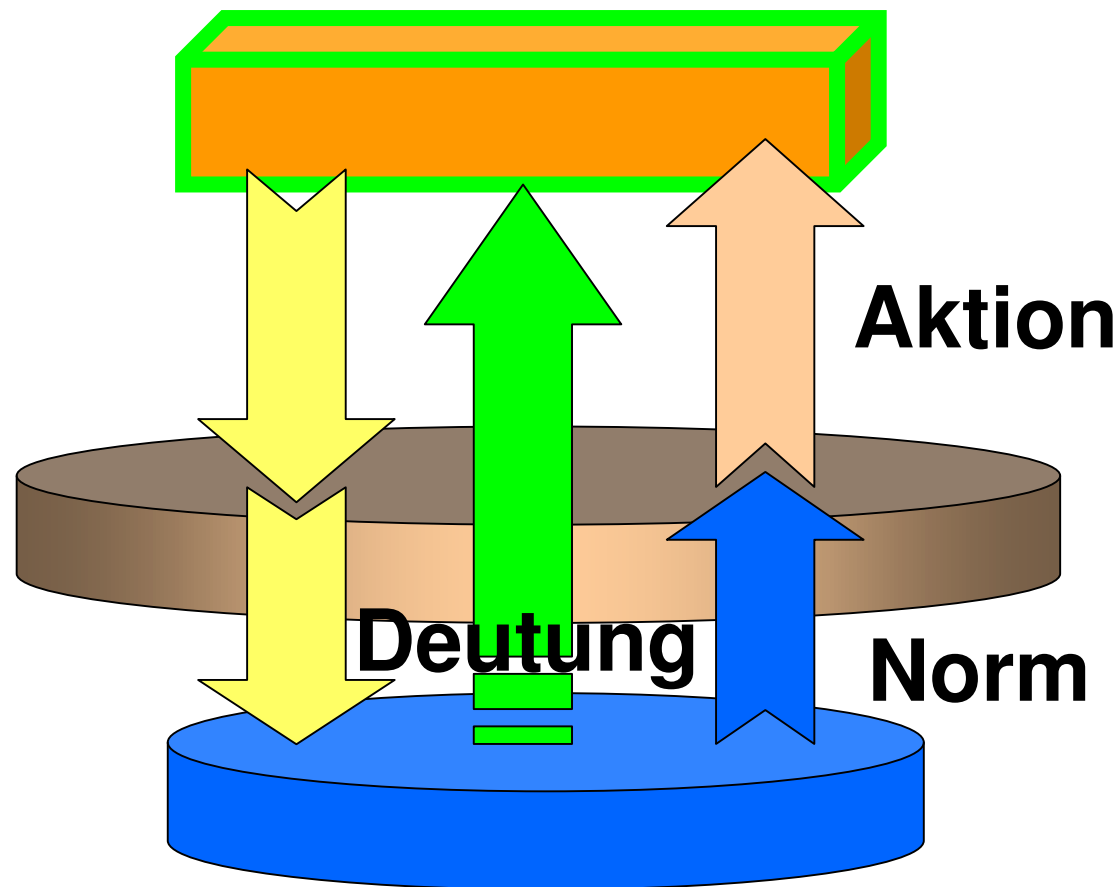

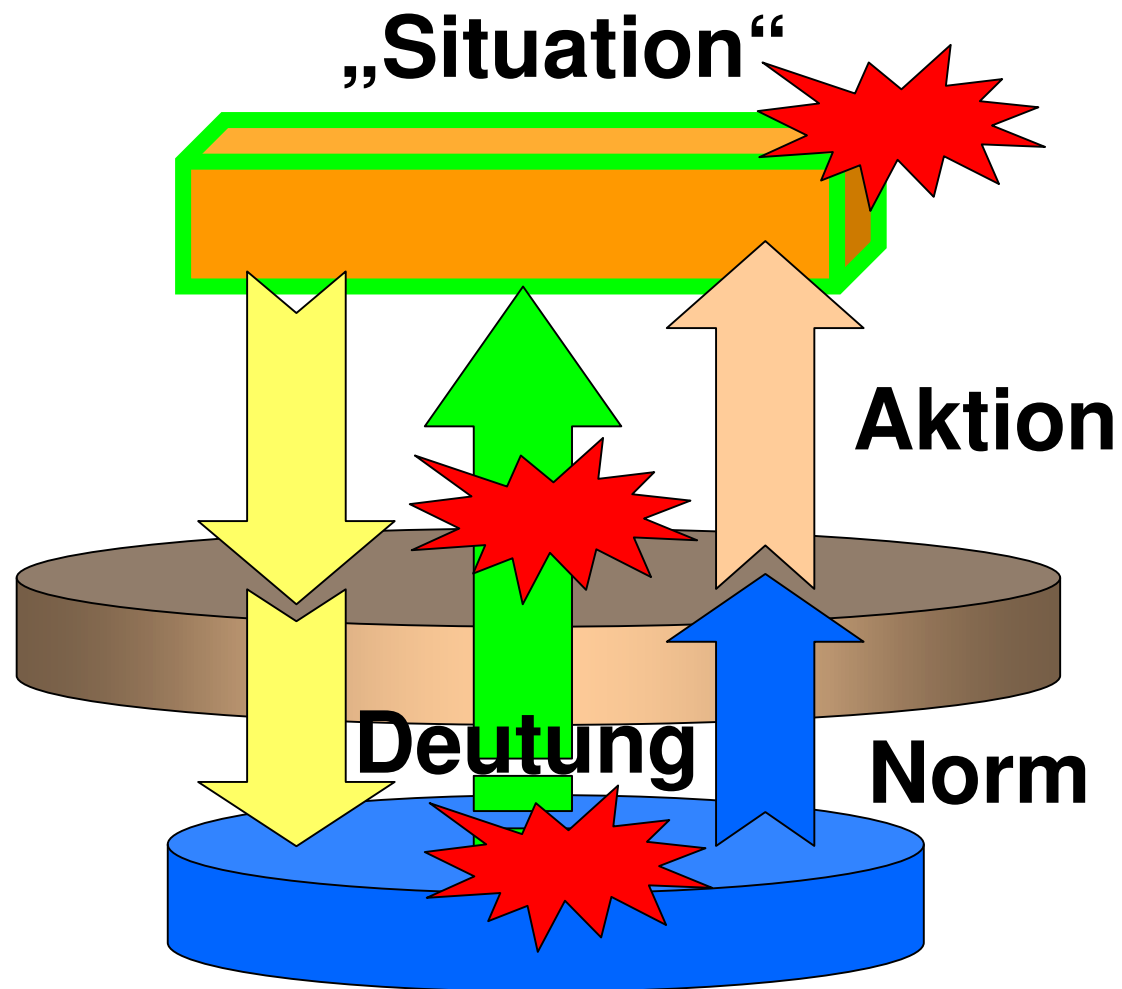

„Situation“

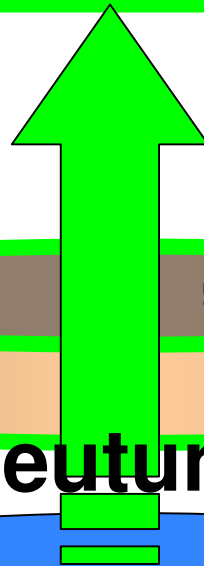
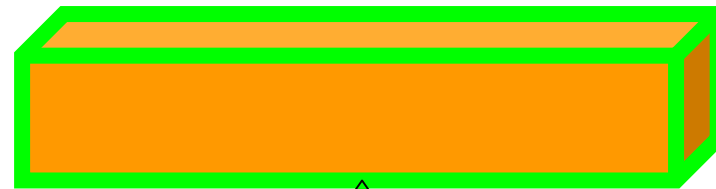

„Rolle“

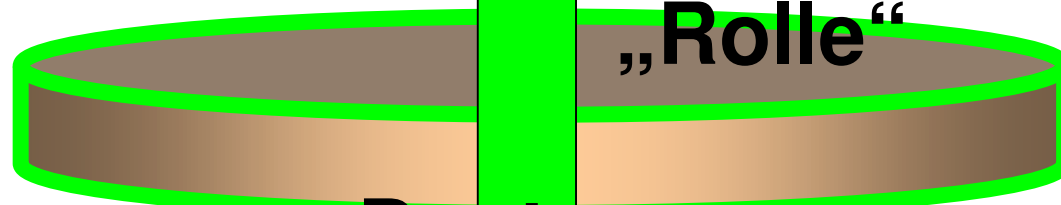

Deutung

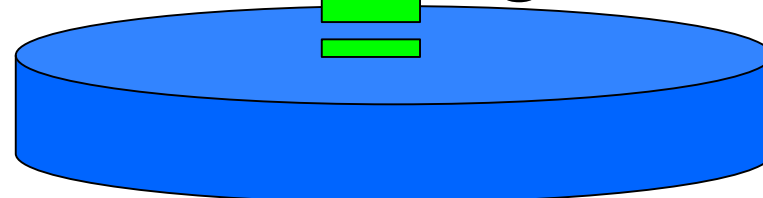

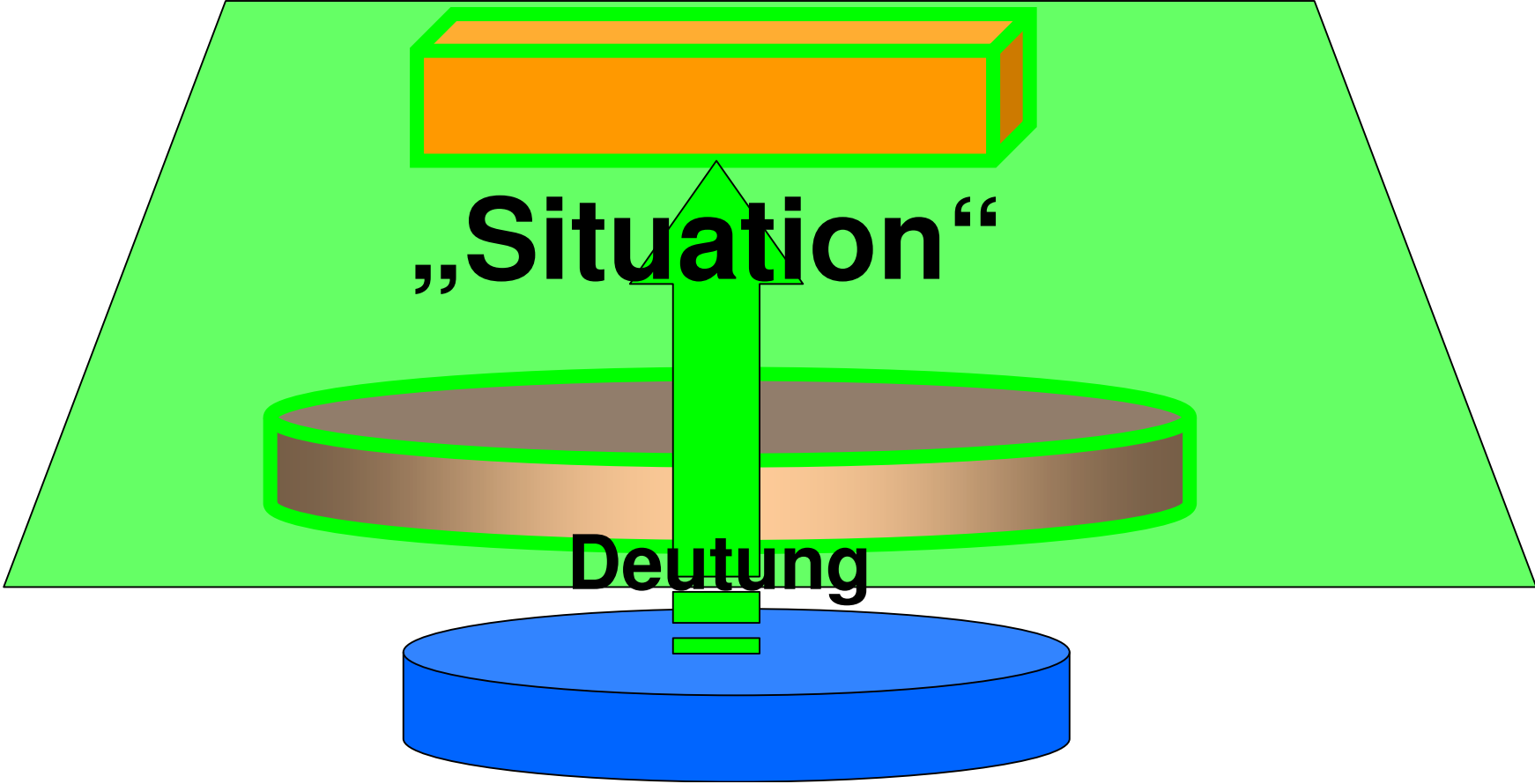

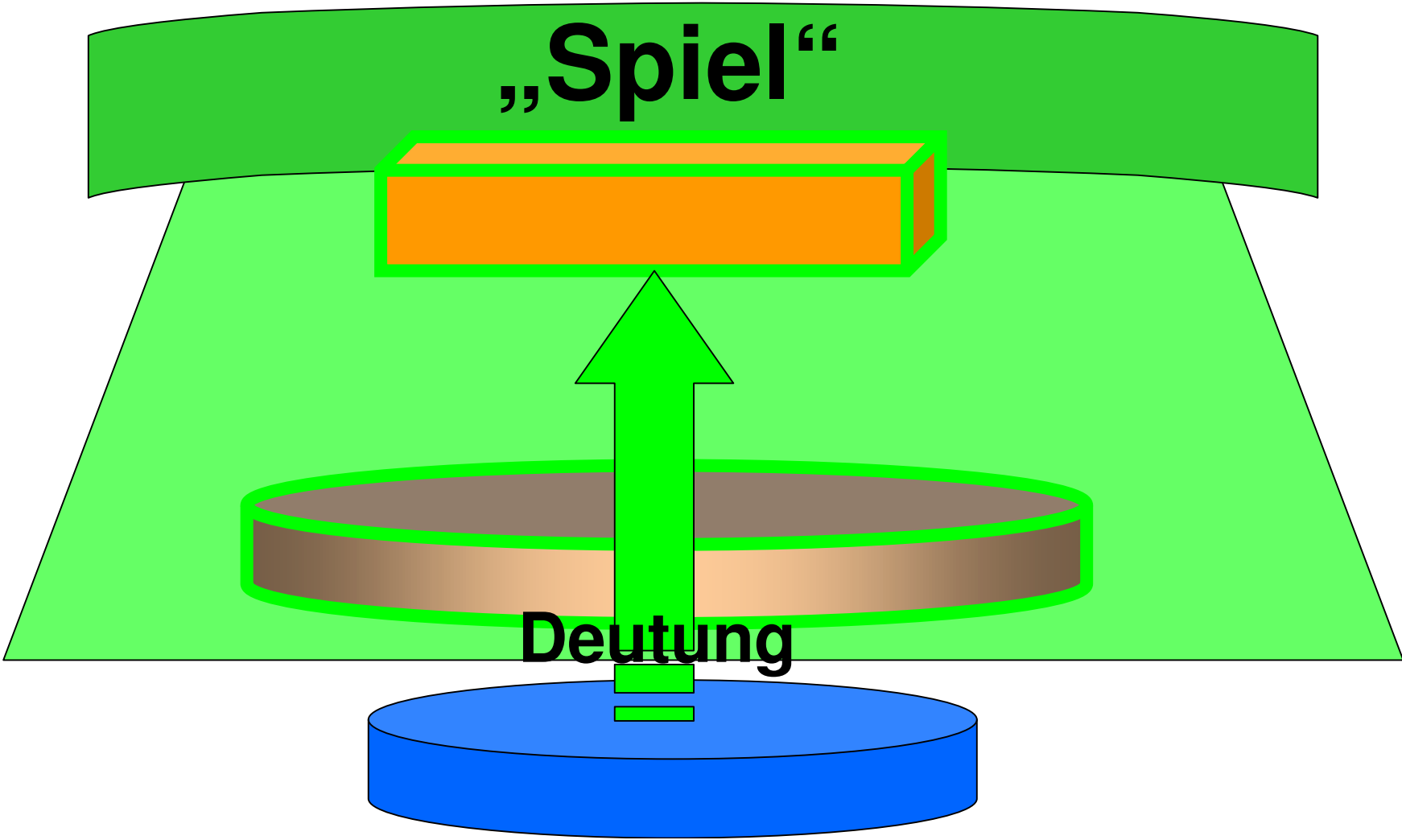

„Spiel“

Deutung

Sinn-Welt

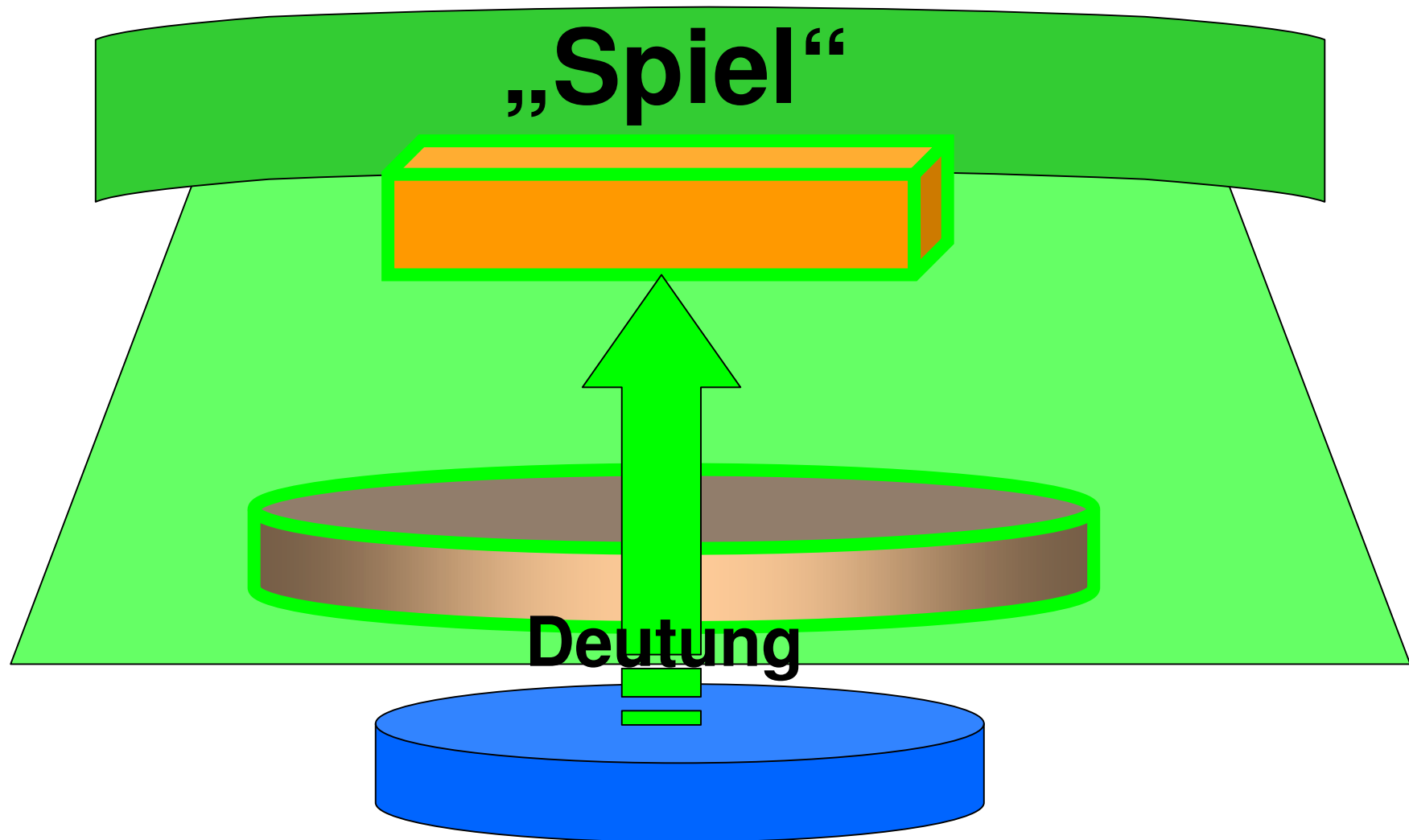

Sinn-Welt

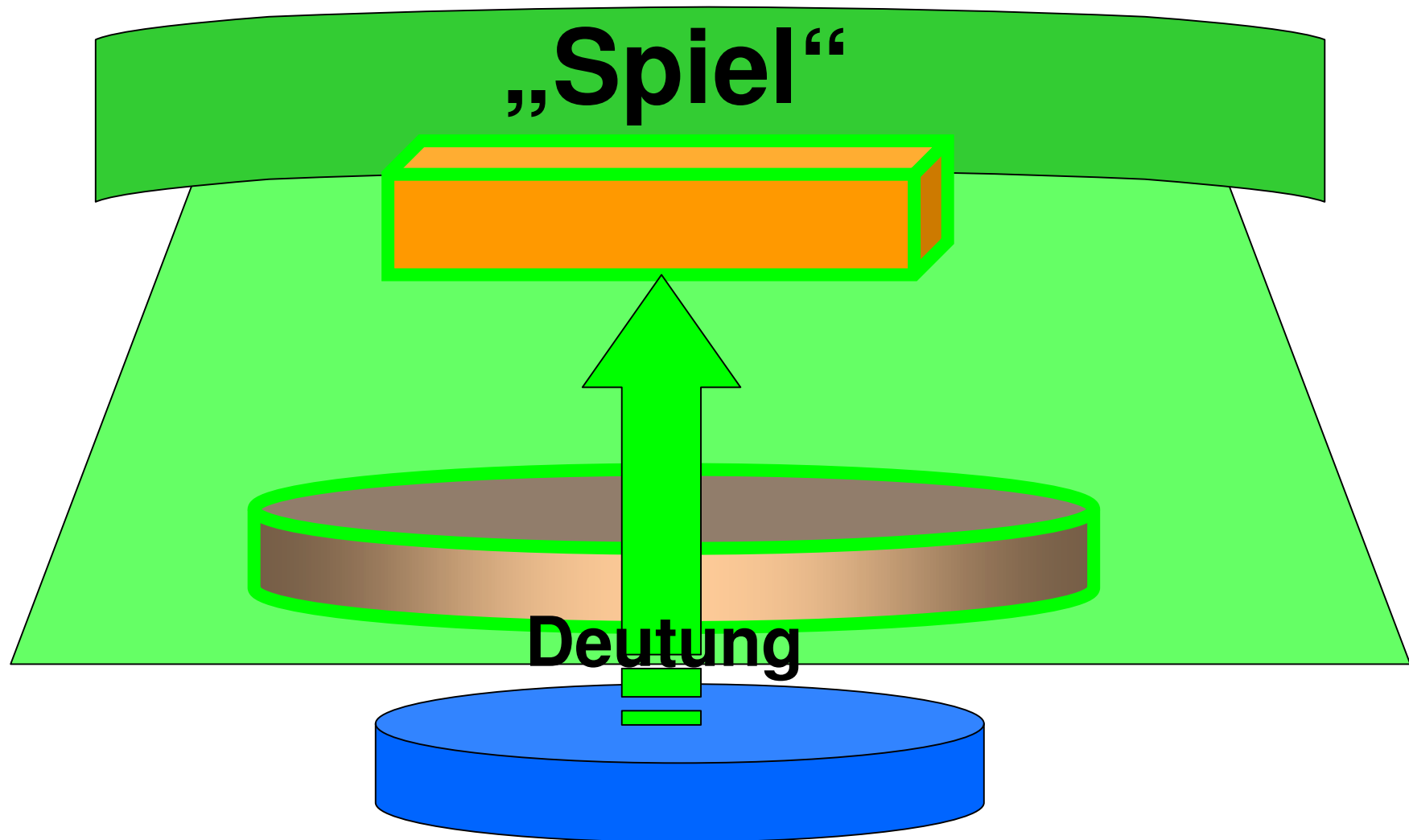

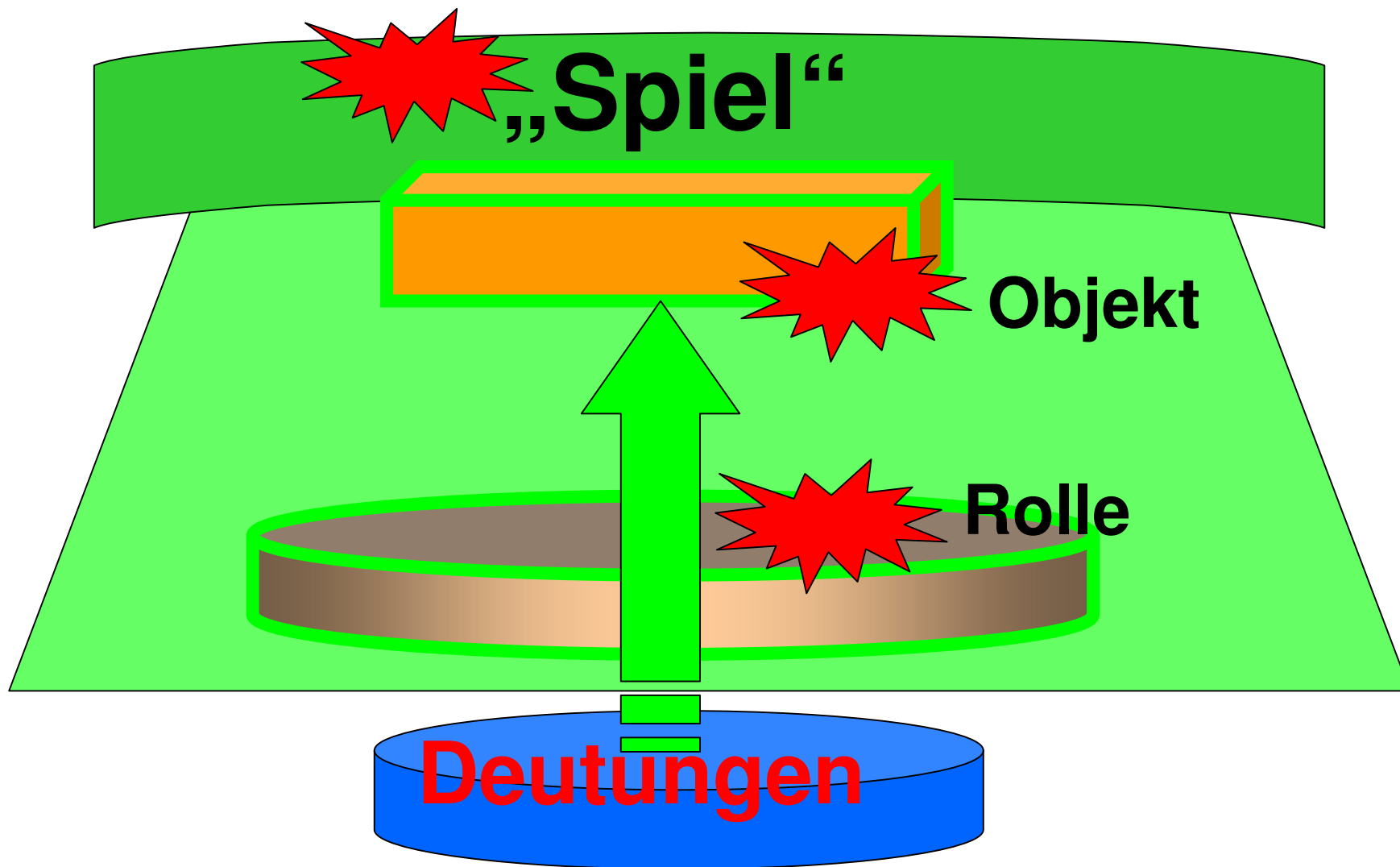

Strukturhintergrund

UNIVERSALIA ANTE REM

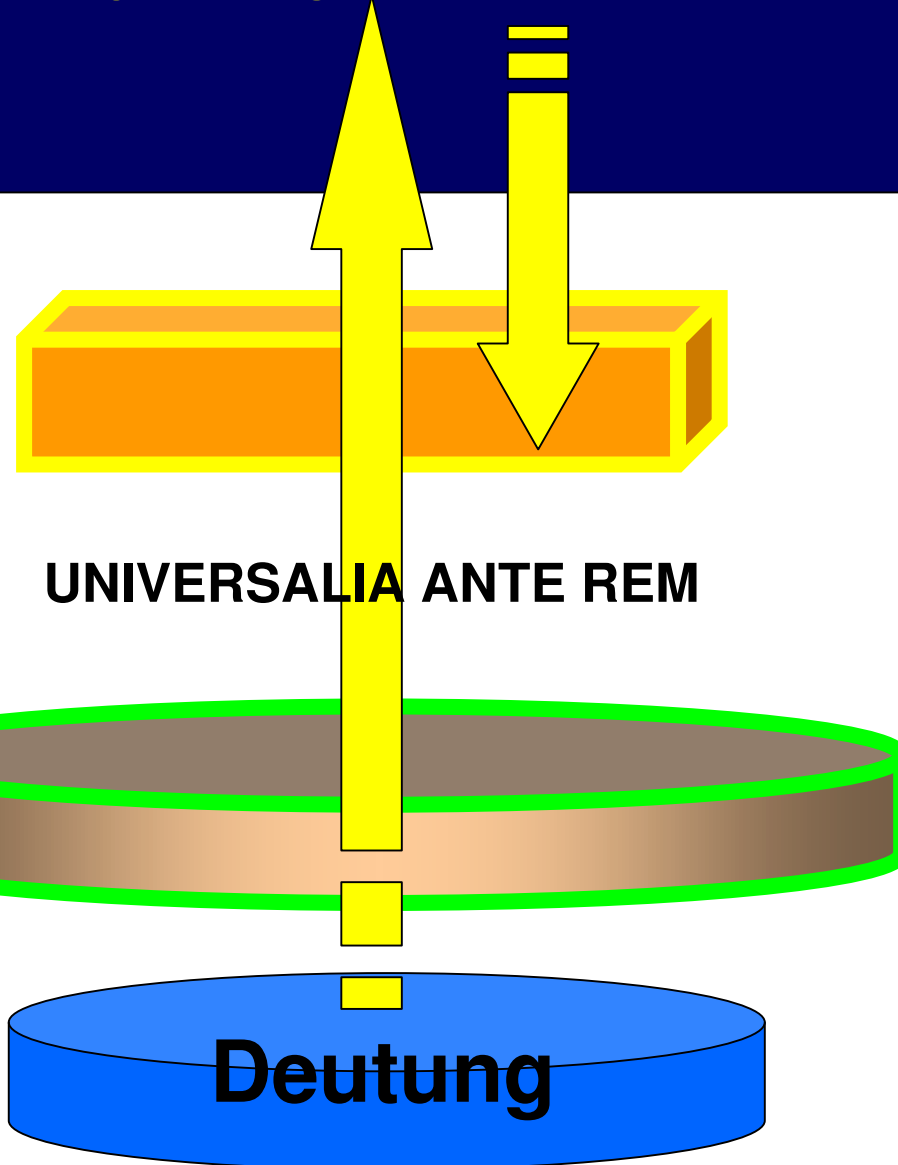

Strukturhintergrund

UNIVERSALIA ANTE REM

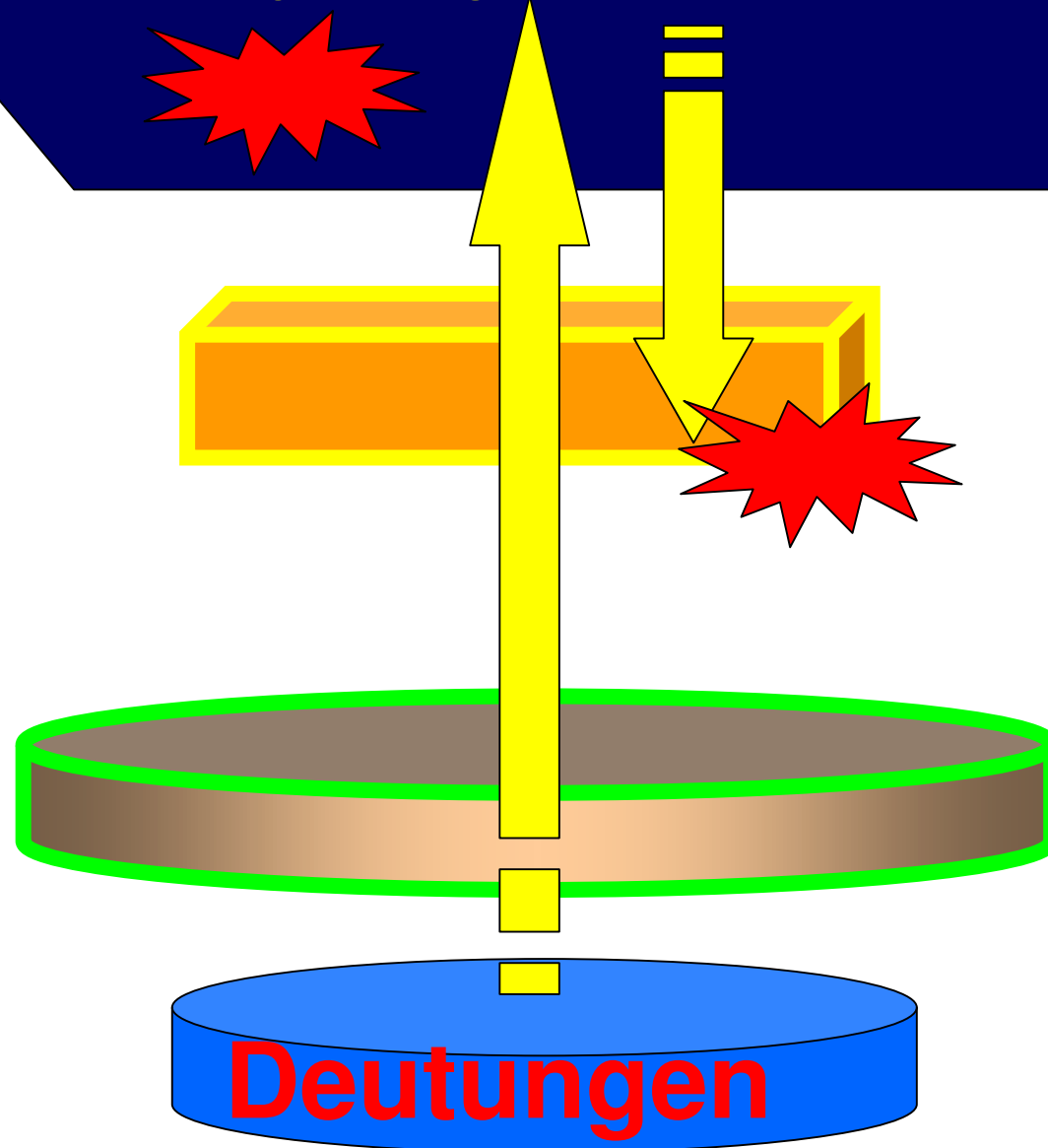

Verifikation/Falsifikation

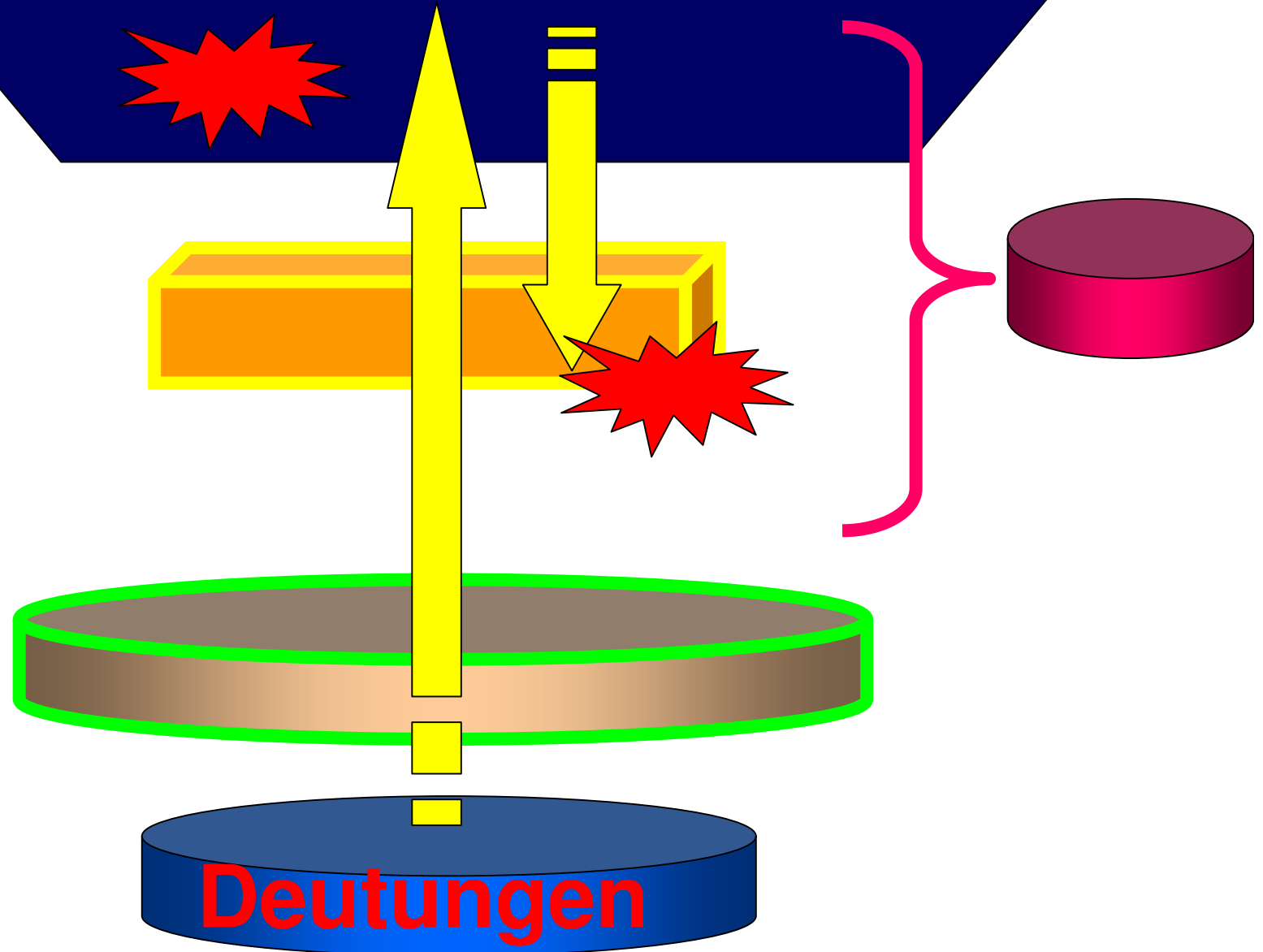

Verifikation/Falsifikation

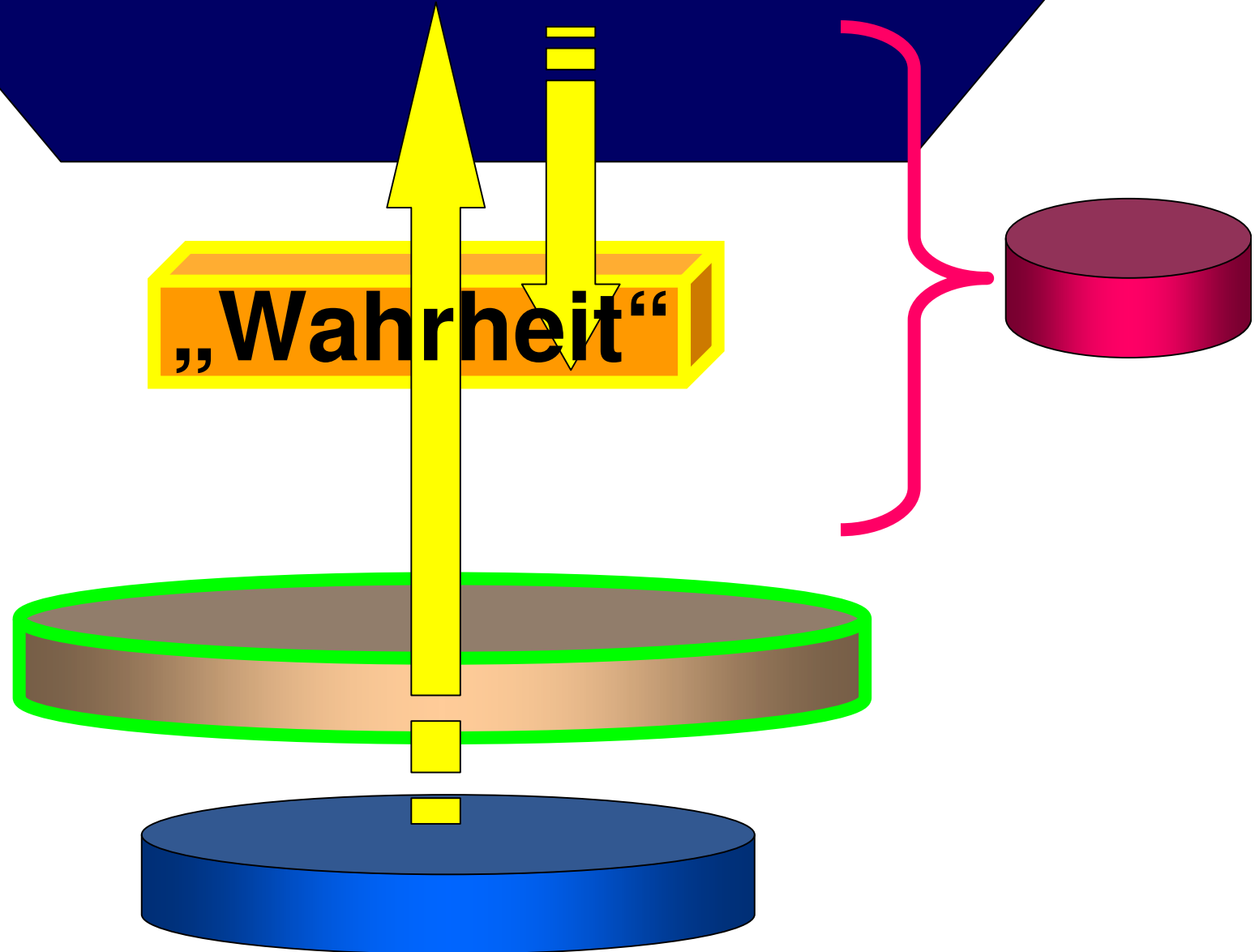

Recht

rechtliche Bedeutung



Recht

**„Unterliegt nicht
der rechtlichen Deutung“**

**„reines“
Faktum**



Recht

Tabu

**„reines“
Faktum**



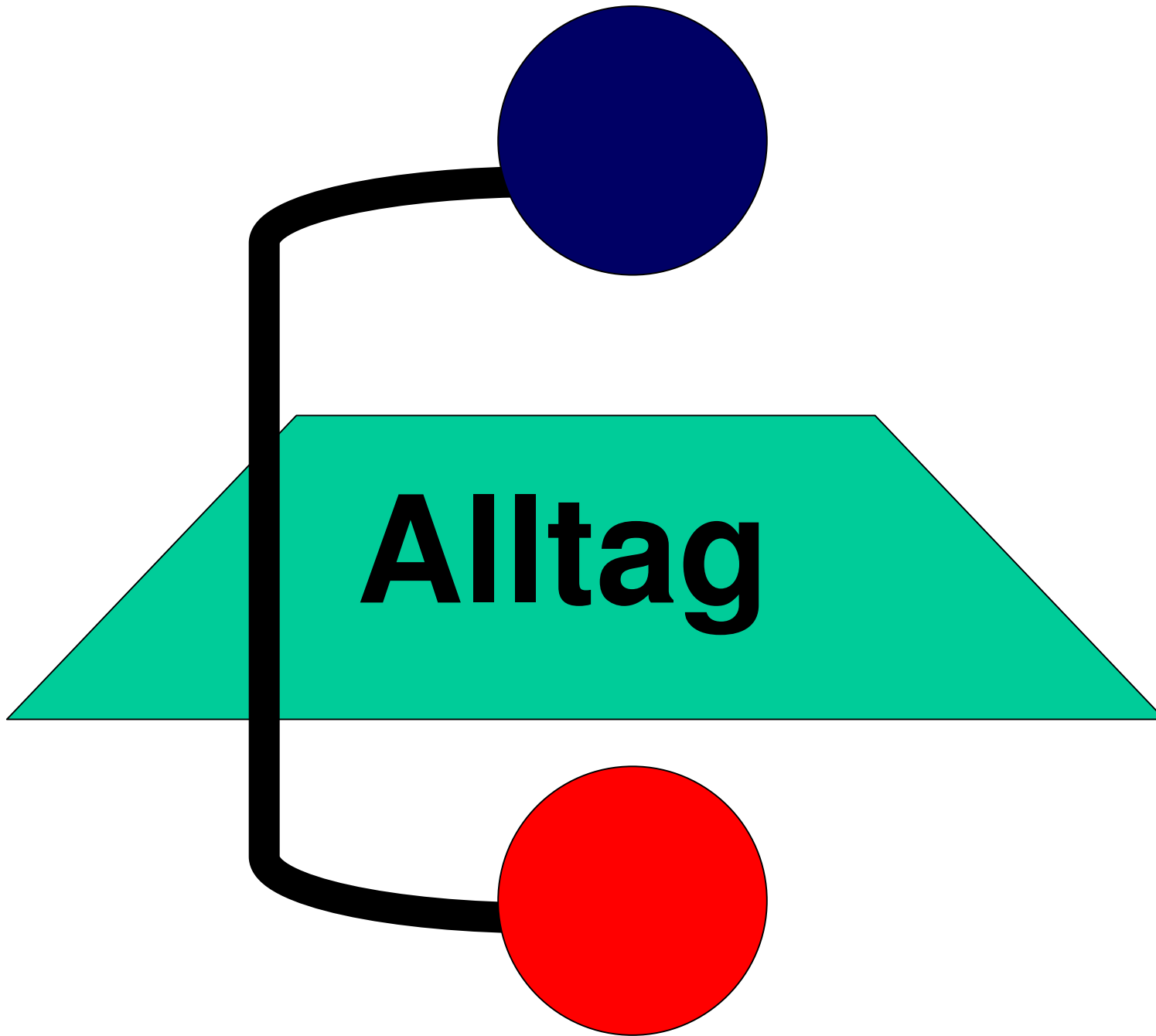

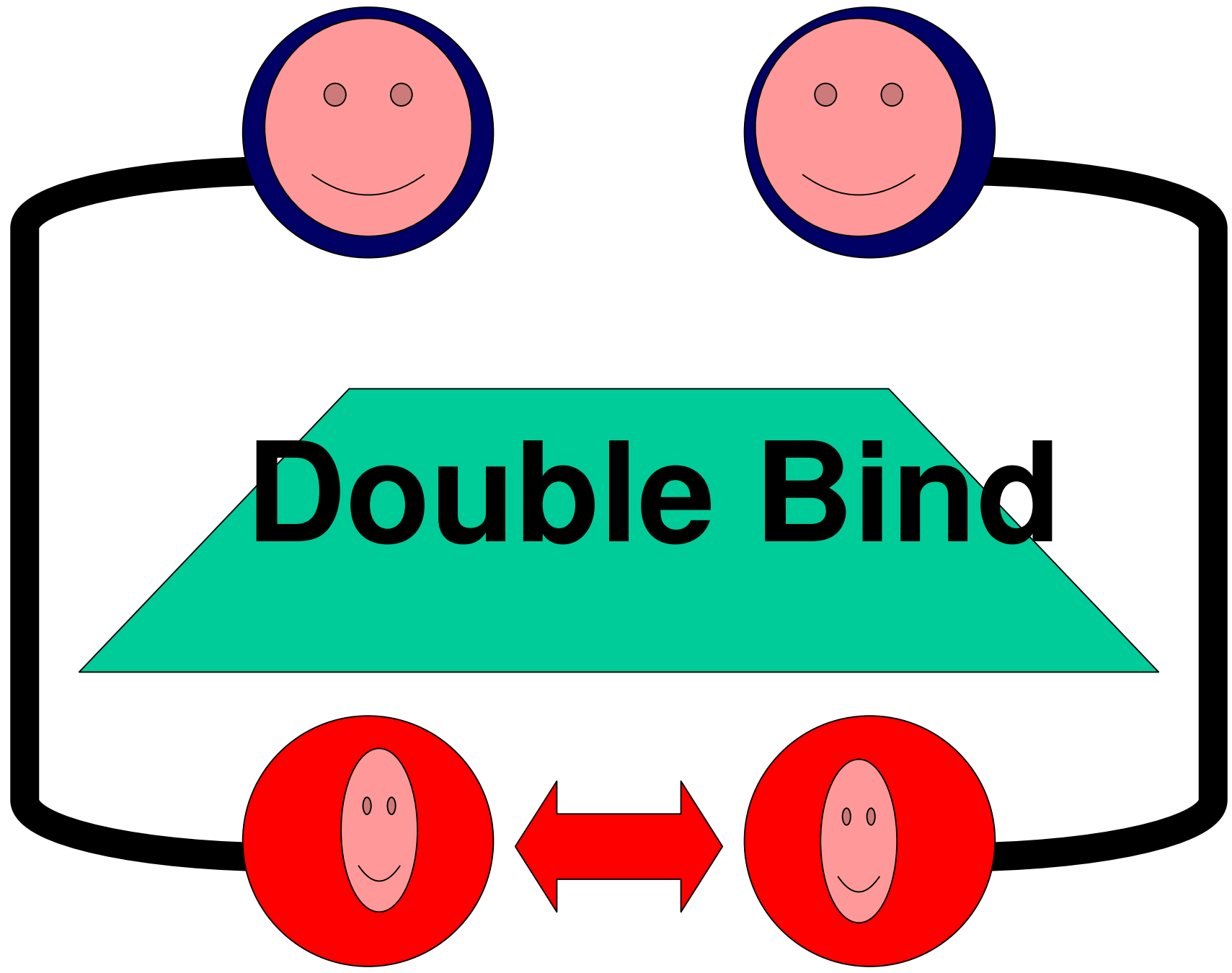

***„Warüber man nicht reden soll,
darüber muss man schweigen“***

(frei nach Wittgenstein)

lachmayer@chello.at

