

# Versuchung Jesu in der Wüste

2014 03 09, A, Erster Fastensonntag  
Aus dem Evangelium nach Matthäus, Mt 4,1-11

<http://www.liturgie.de/wortgottesfeier/index.php?datei=lesungen2014-03-09>  
[www.legalvisualization.com](http://www.legalvisualization.com), → *Visualization/Religion/Evangelien und Lesungen*

*Vgl. 2013 02 17 Evangelium, Lukas 4,1-13*

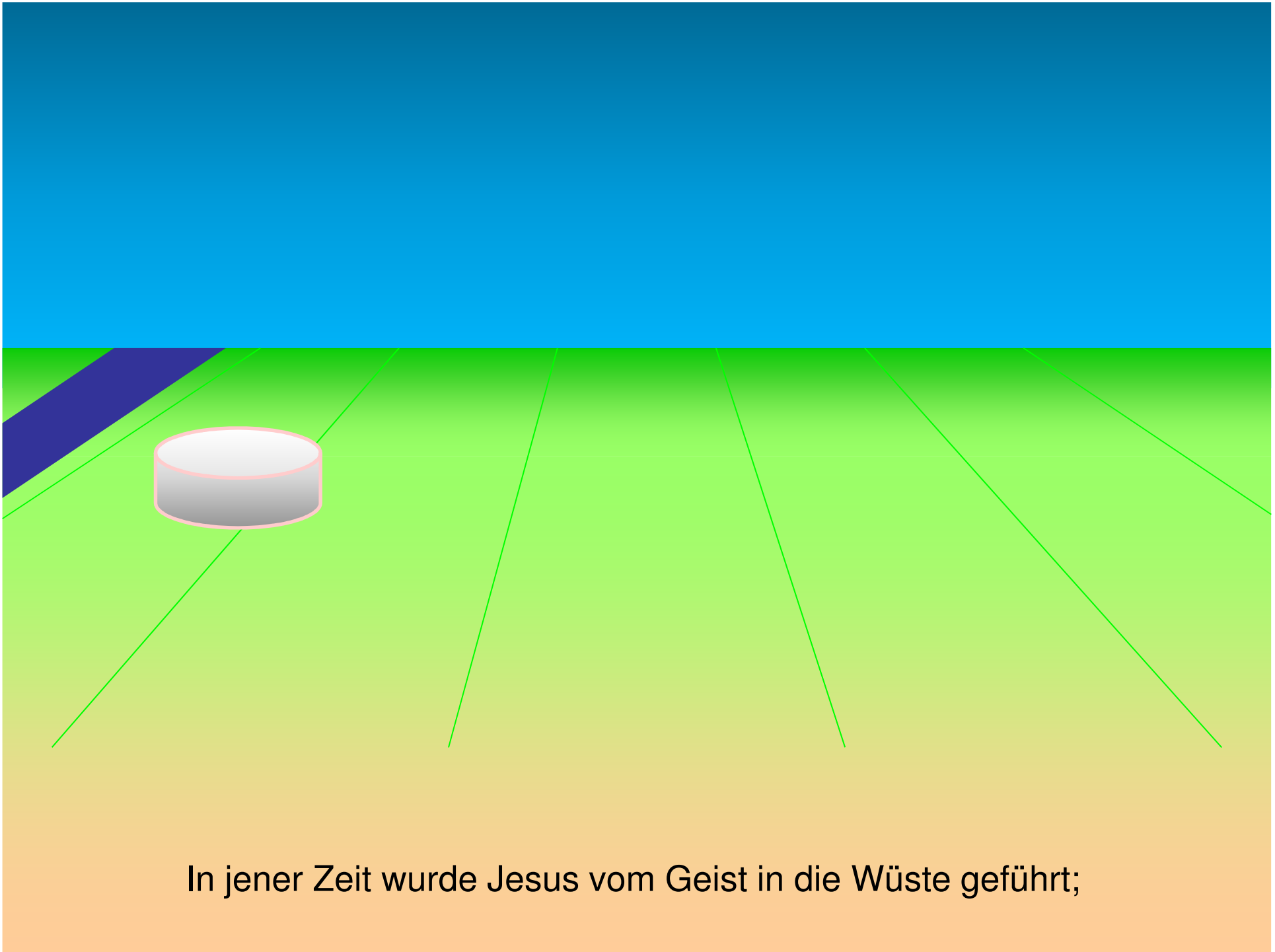

In jener Zeit wurde Jesus vom Geist in die Wüste geführt;

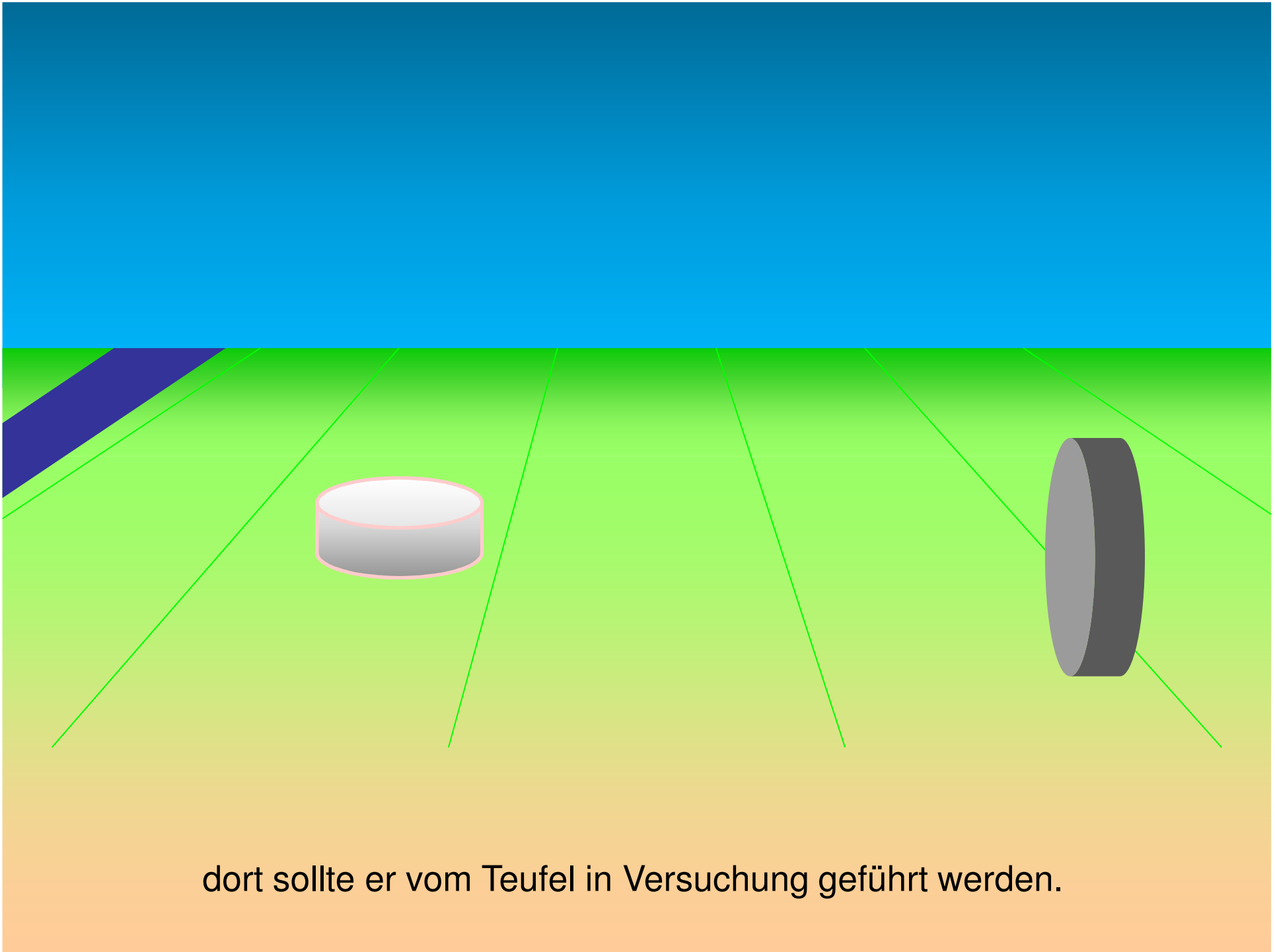

dort sollte er vom Teufel in Versuchung geführt werden.

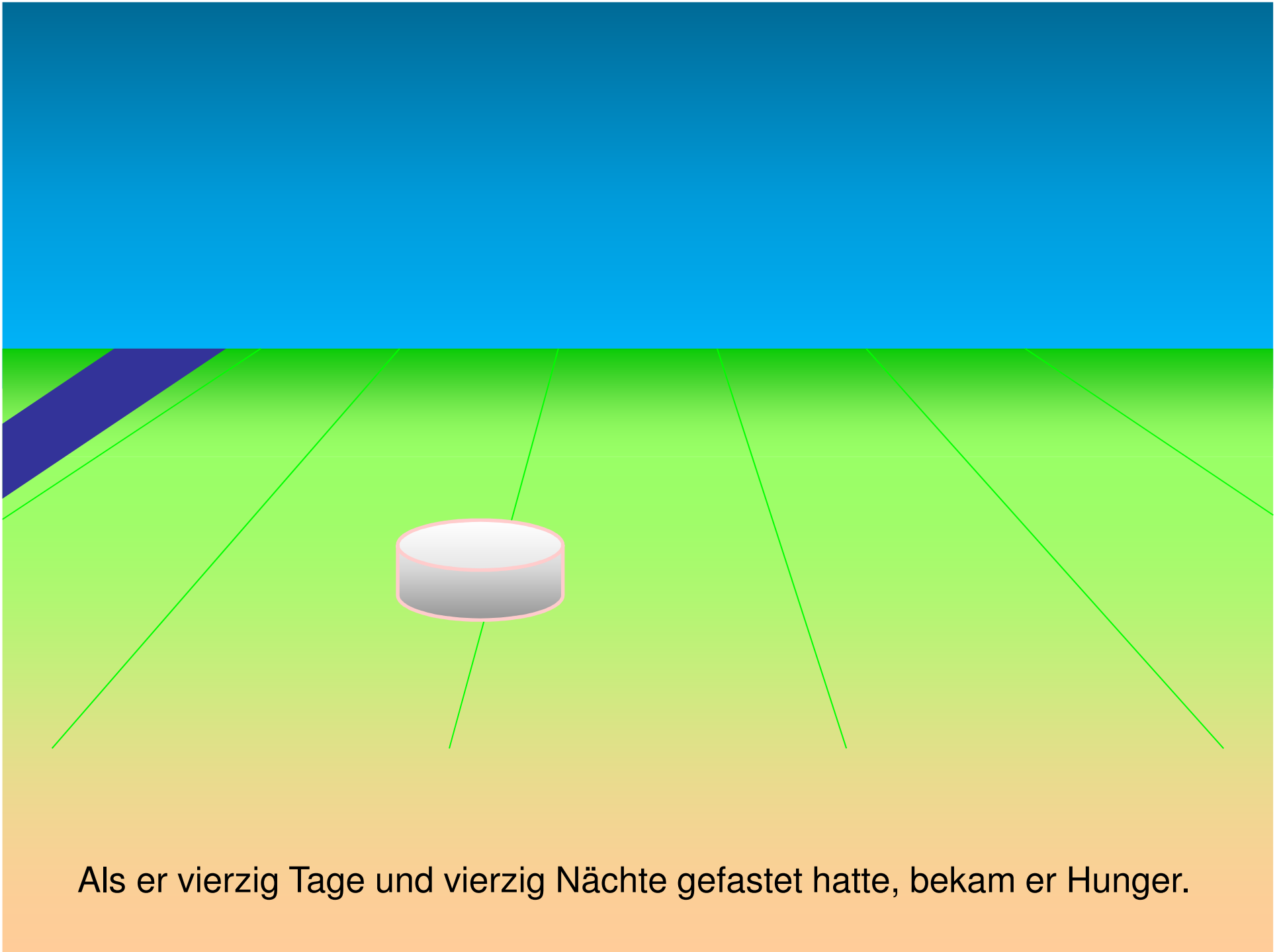

Als er vierzig Tage und vierzig Nächte gefastet hatte, bekam er Hunger.

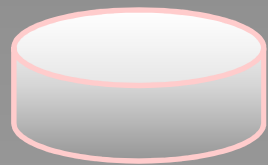

Da trat der Versucher an ihn heran und sagte

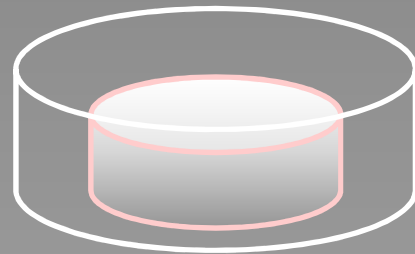

Wenn du Gottes Sohn bist

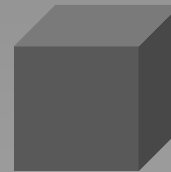
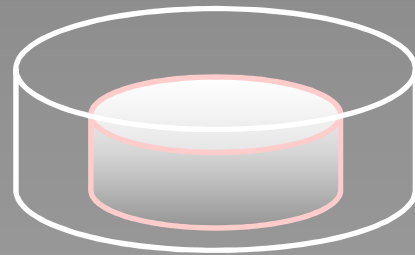

so befehl, dass aus diesen Steinen

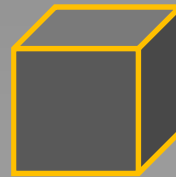
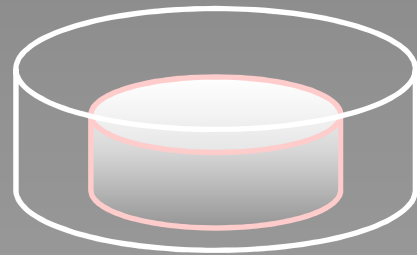

Brot wird.



Er aber antwortete:

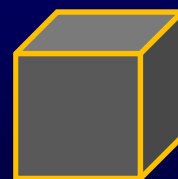
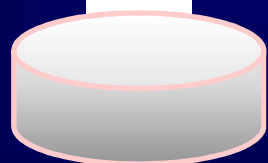

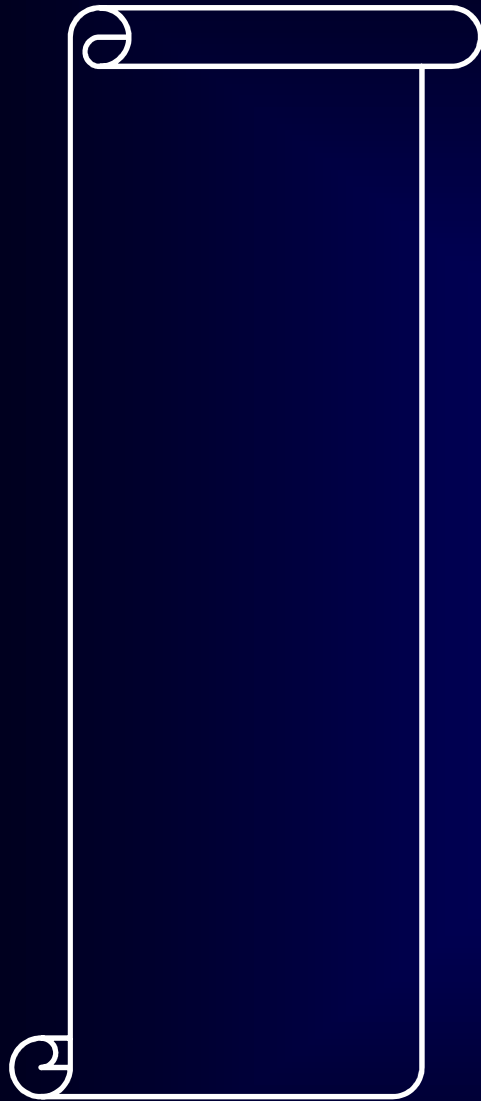

In der Schrift heißt es:

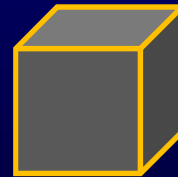
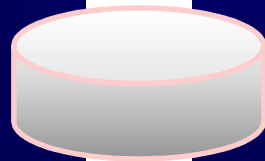

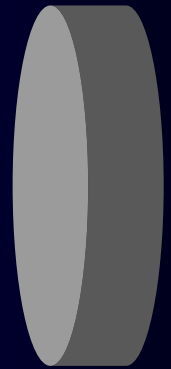
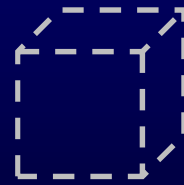
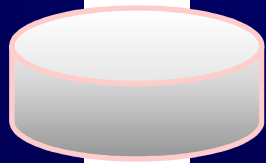
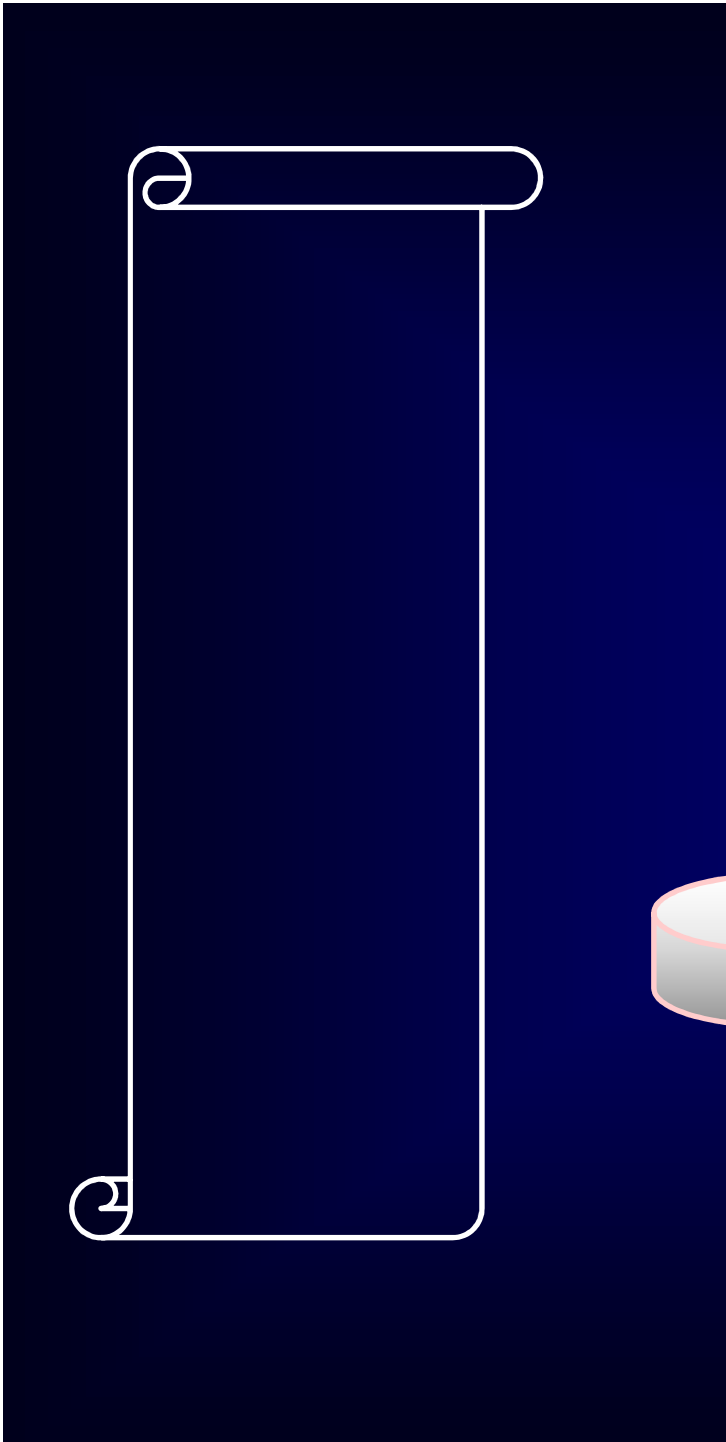

„Der Mensch lebt nicht nur von Brot,

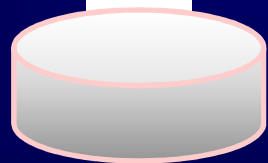

sondern von jedem Wort, das aus Gottes Mund kommt.“

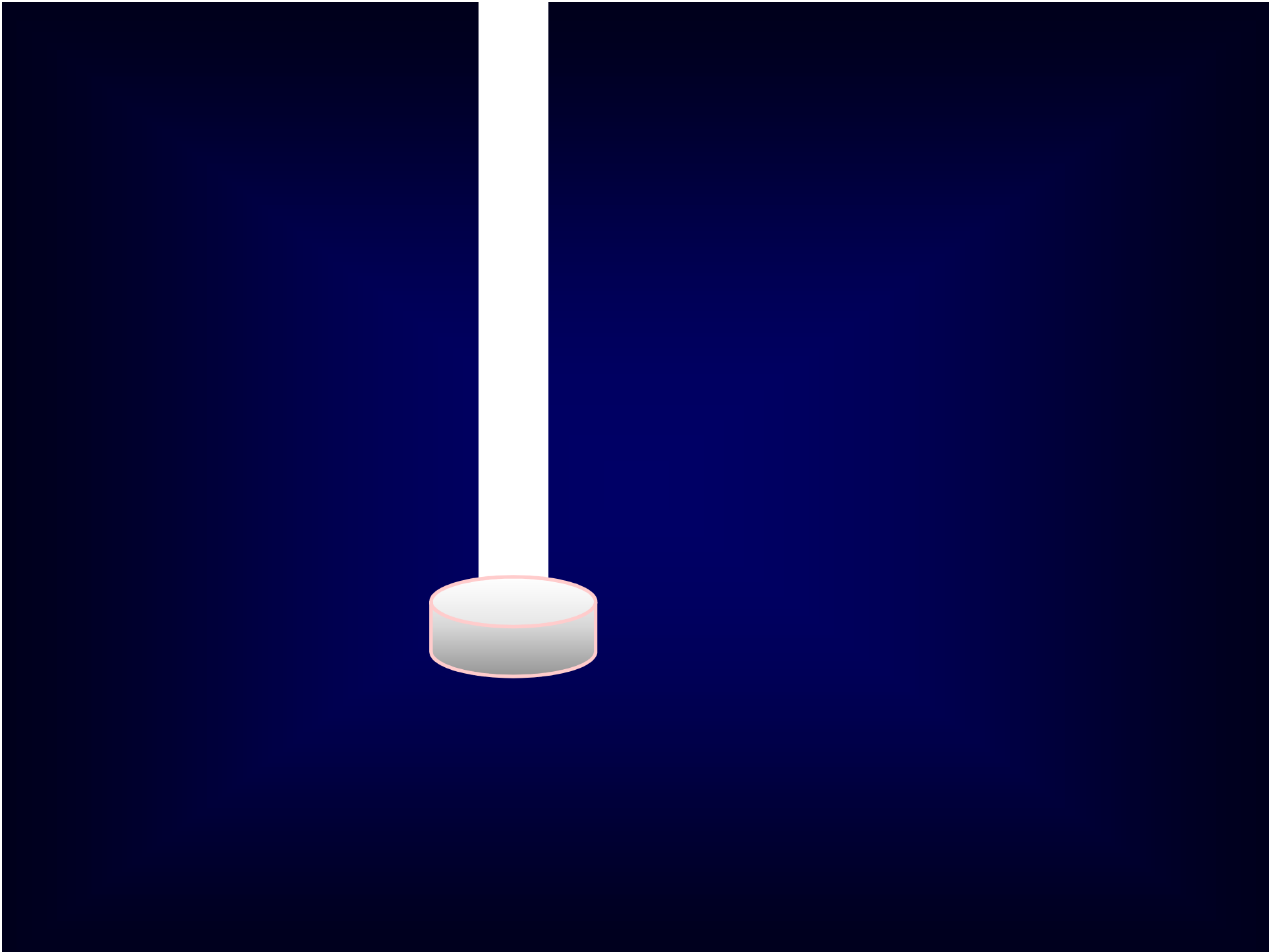

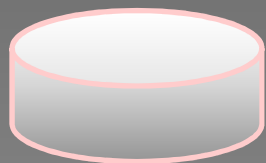

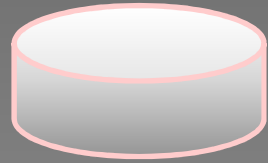

Darauf nahm ihn der Teufel mit sich in die Heilige Stadt,

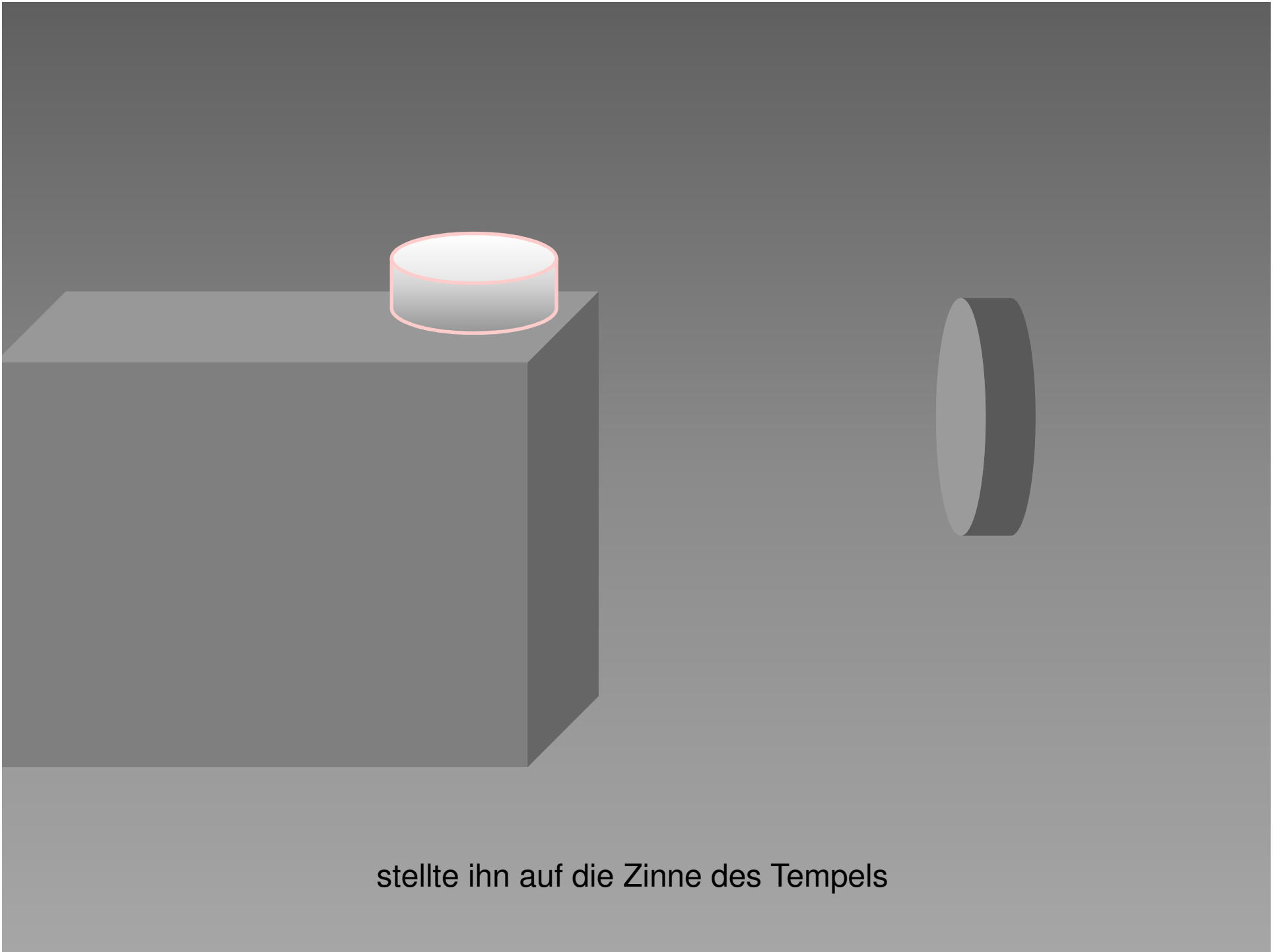

stellte ihn auf die Zinne des Tempels



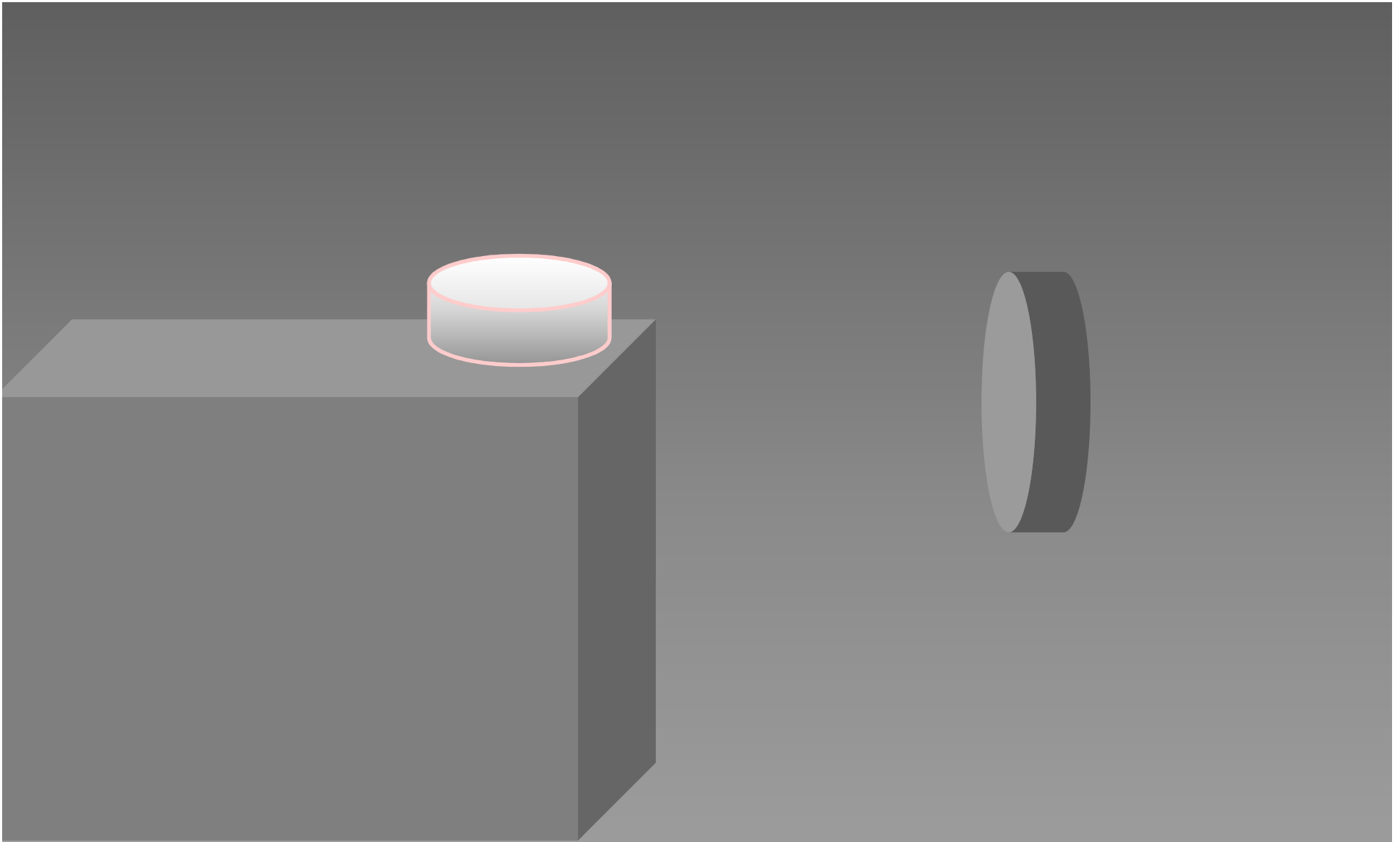

stellte ihn oben auf den Tempel und sagte zu ihm:

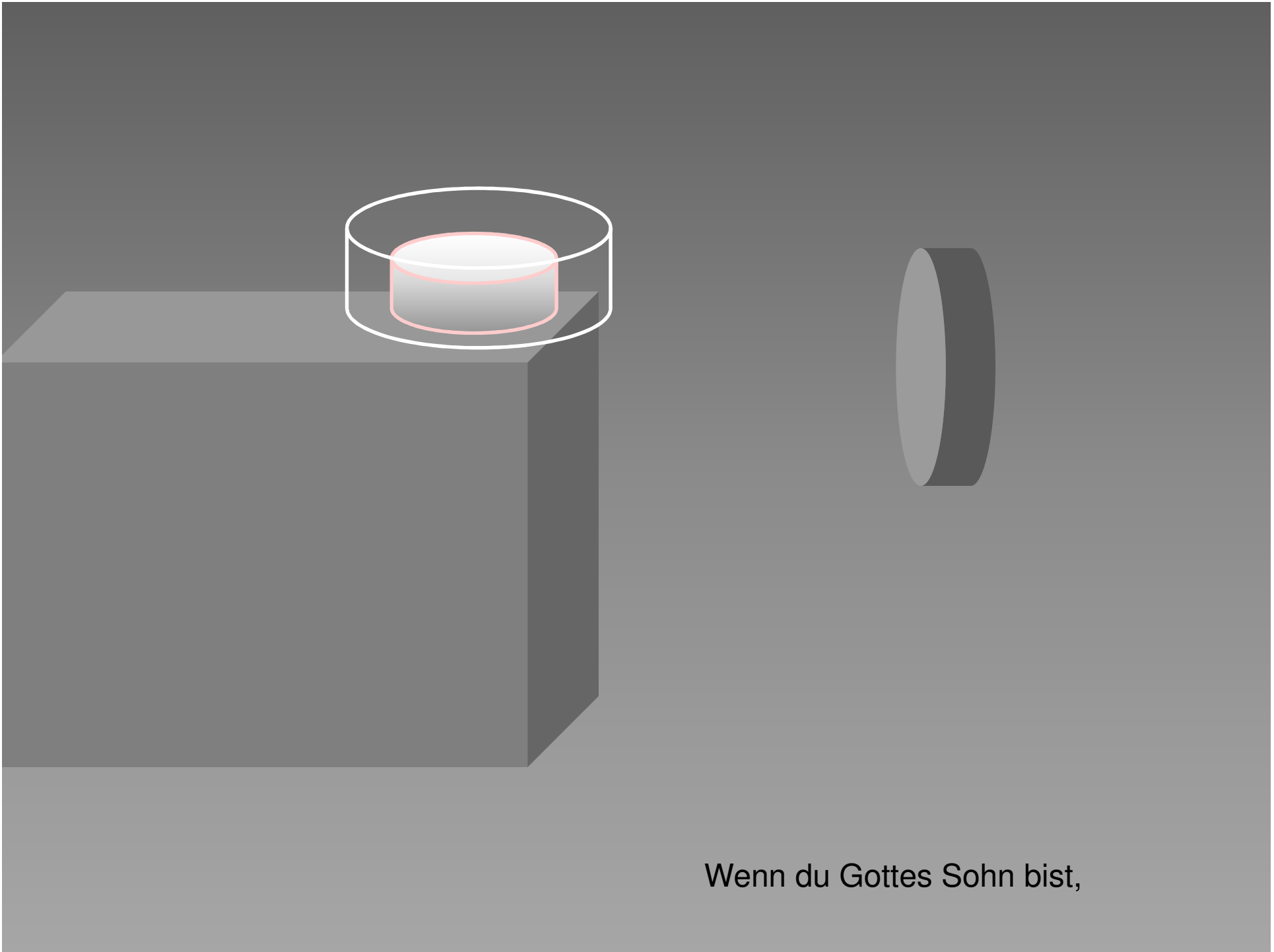

Wenn du Gottes Sohn bist,

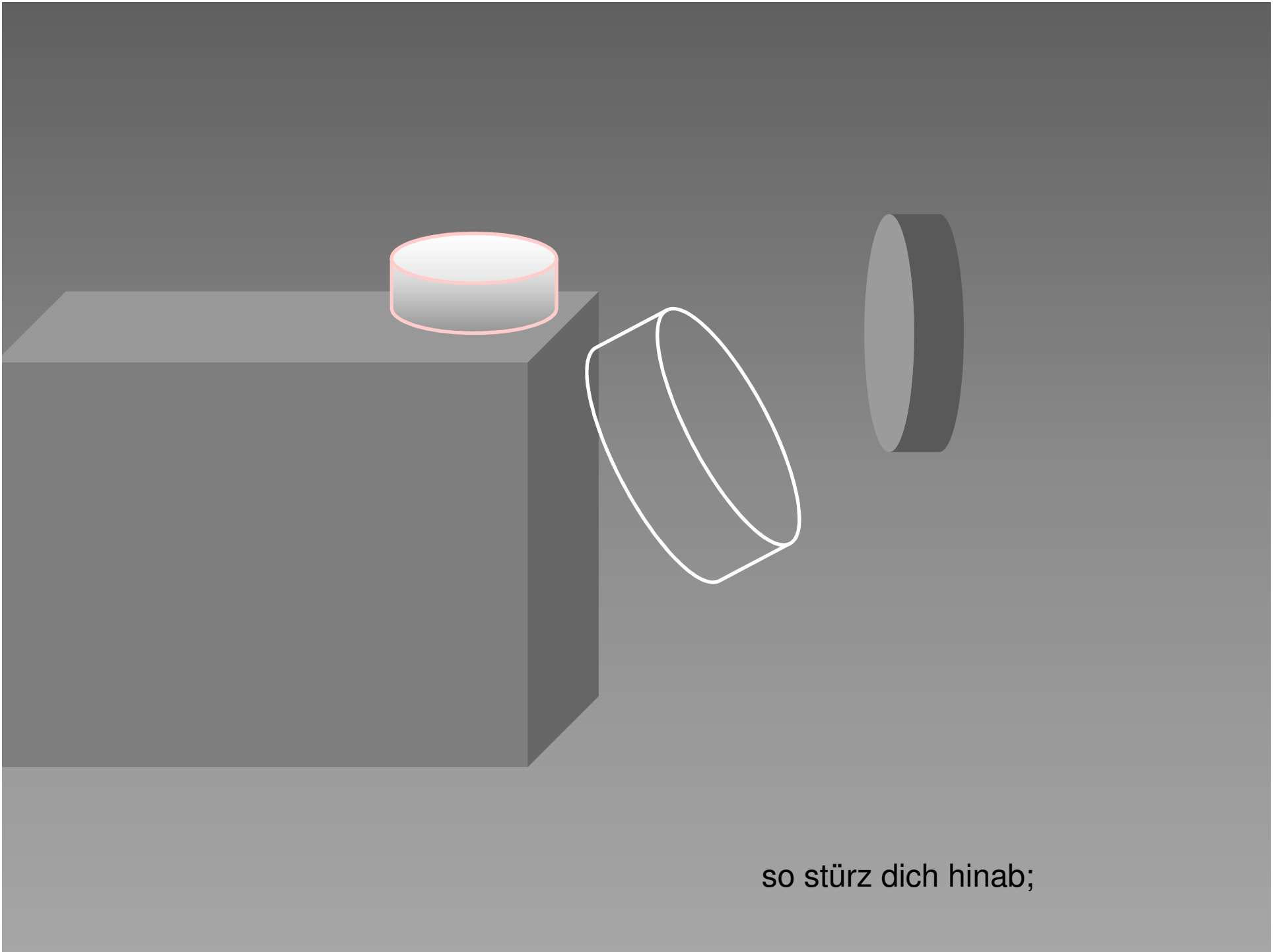

so stürz dich hinab;

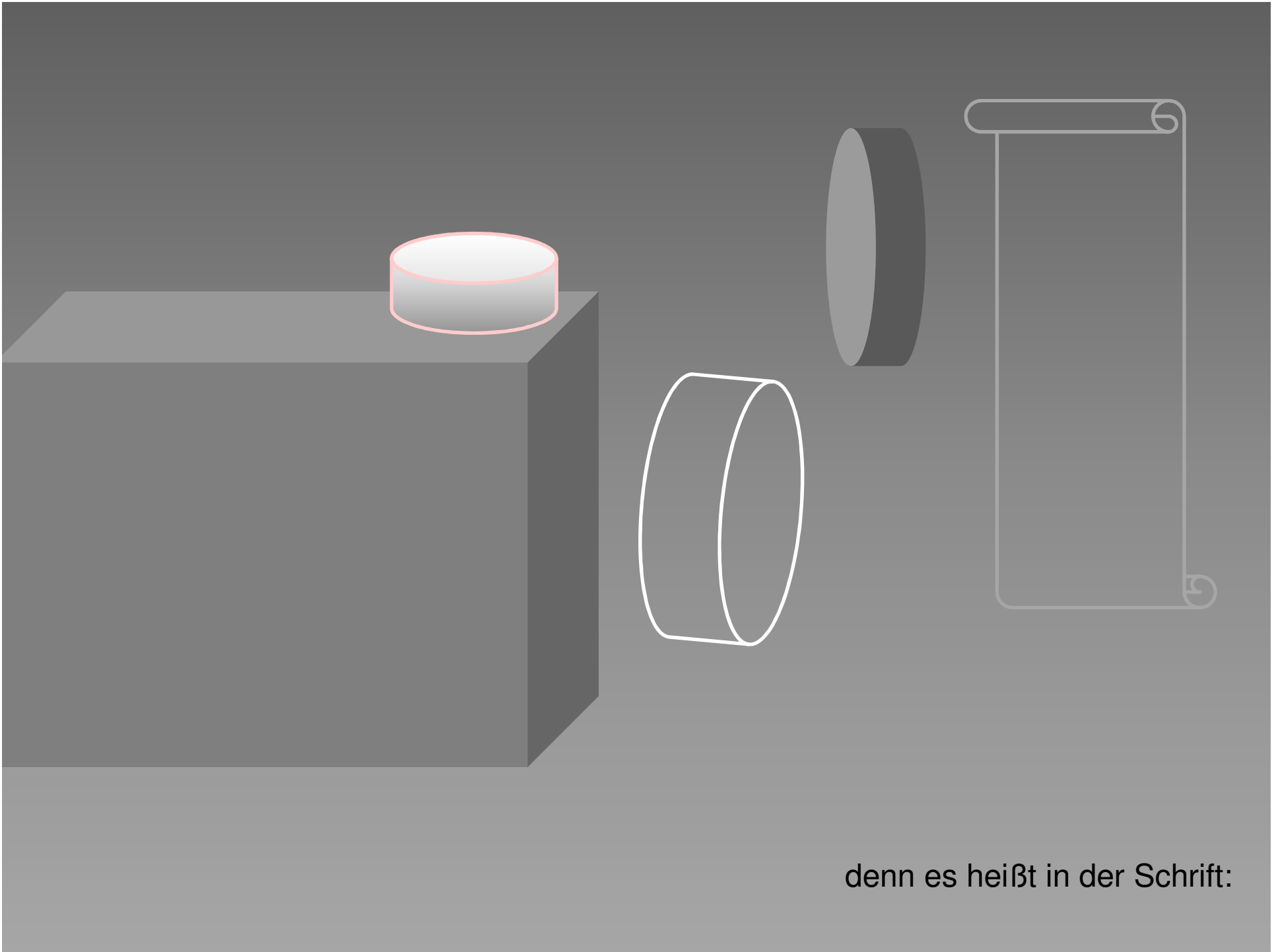

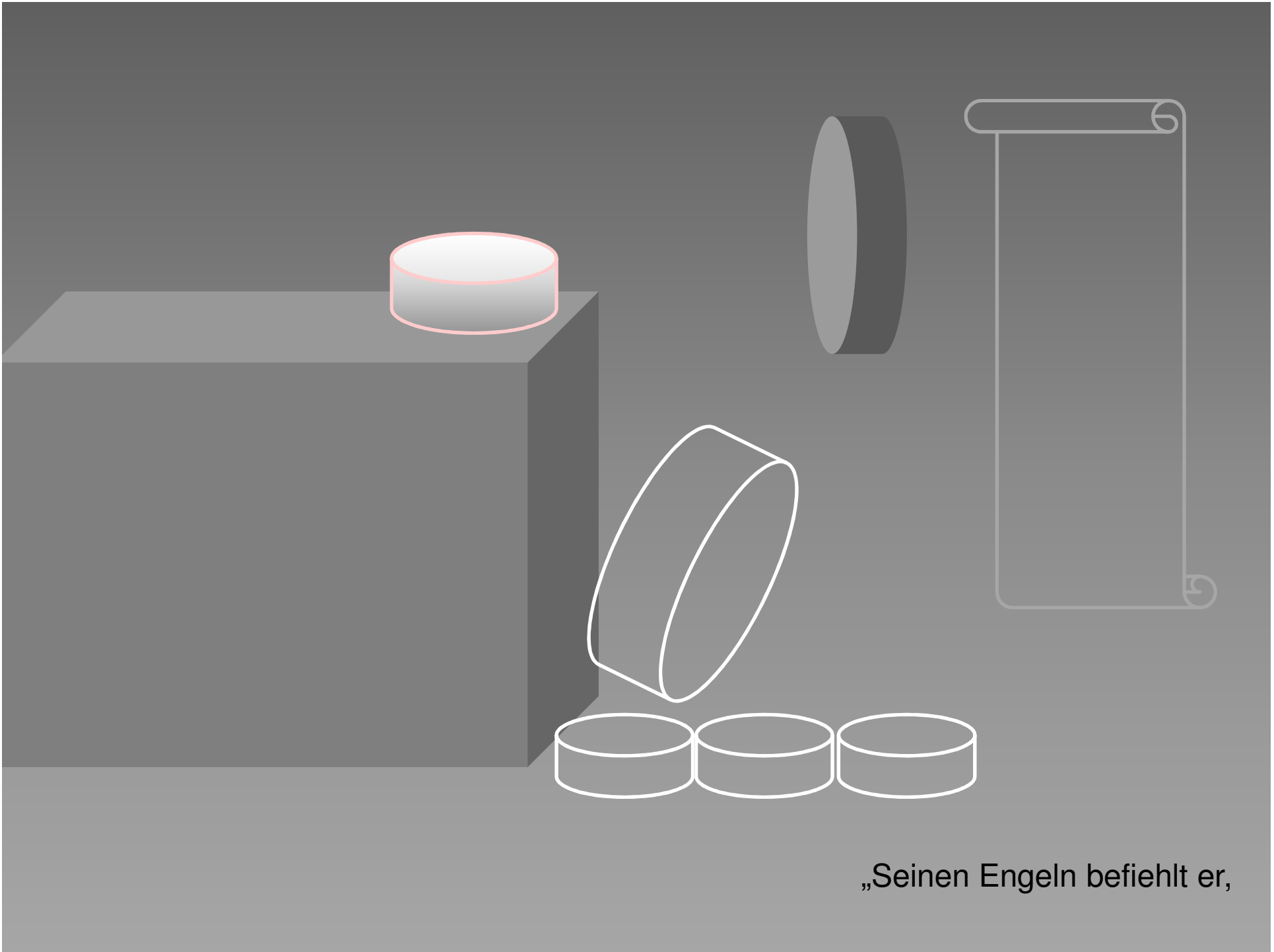

„Seinen Engeln befiehlt er,

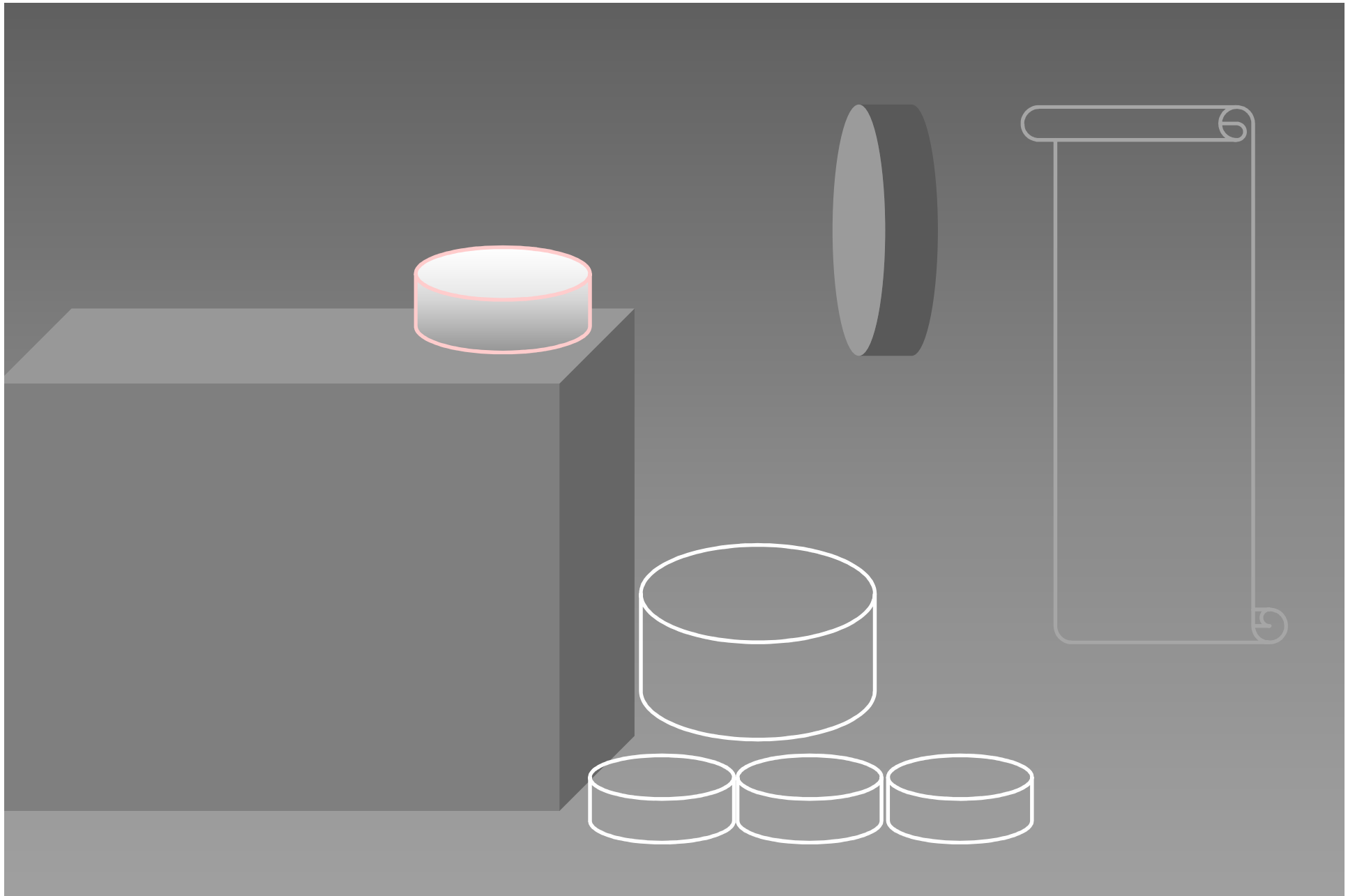

dich auf ihren Händen zu tragen, damit dein Fuß nicht an einen Stein stößt.“

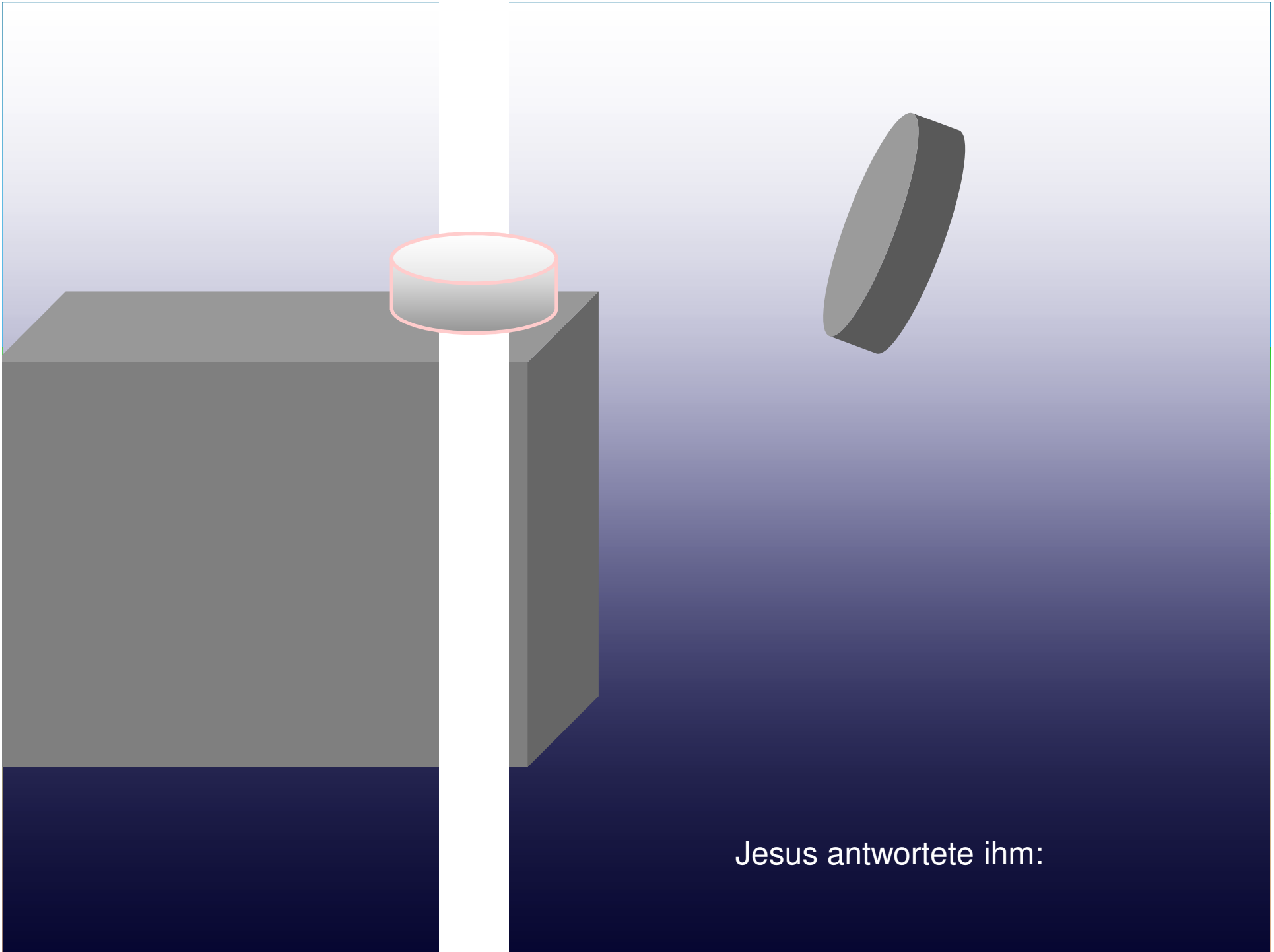

Jesus antwortete ihm:

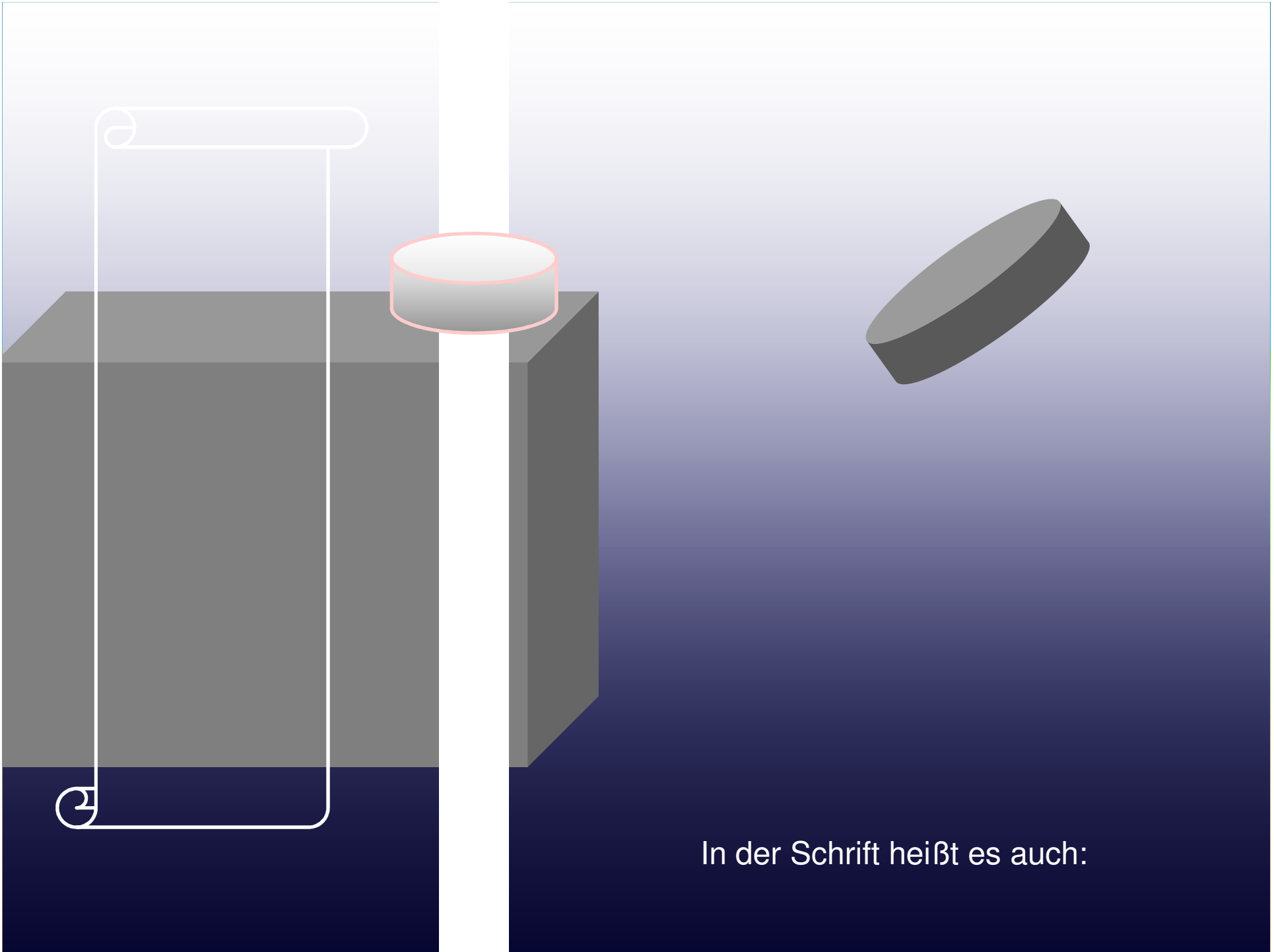



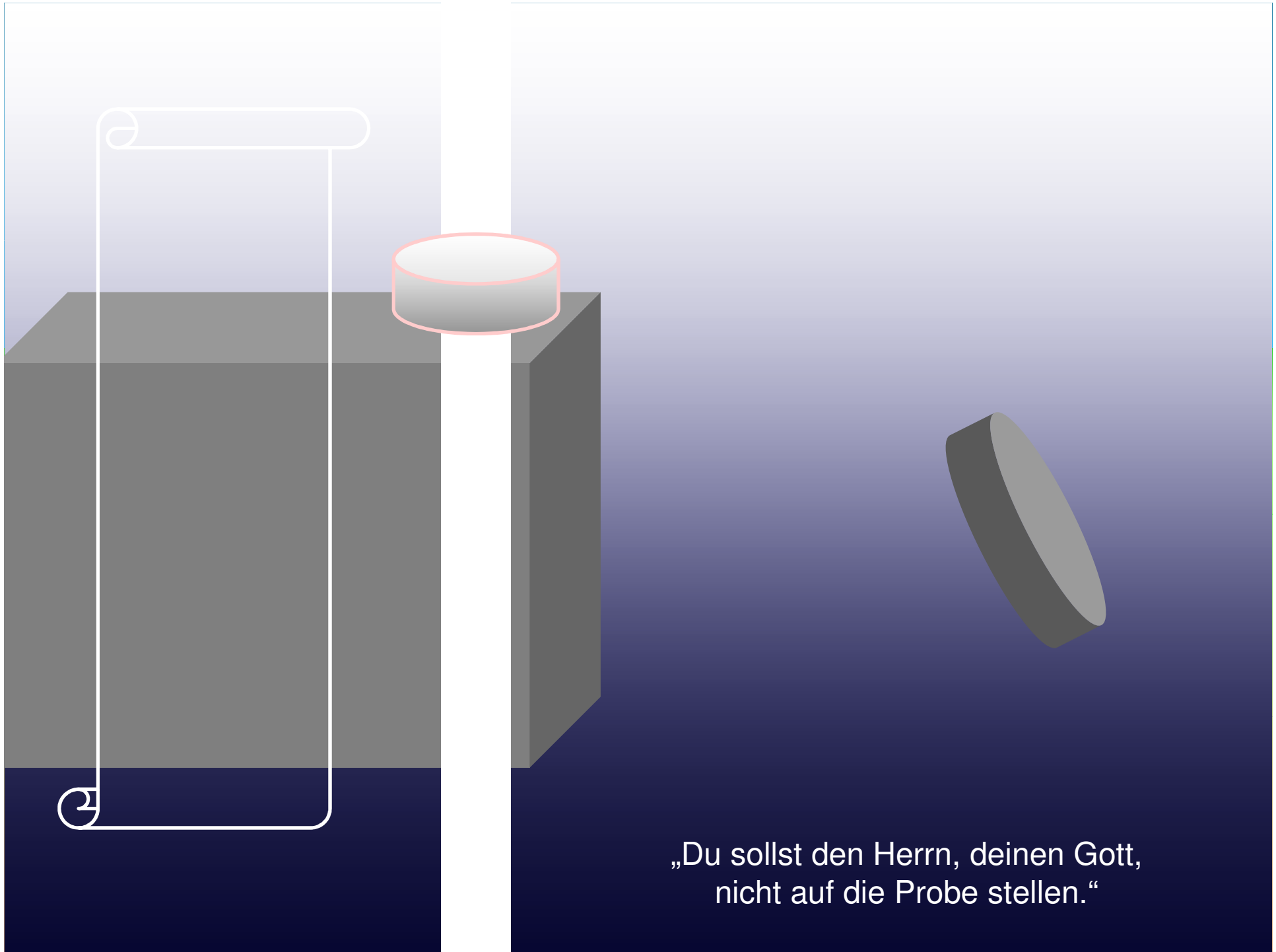

„Du sollst den Herrn, deinen Gott,  
nicht auf die Probe stellen.“

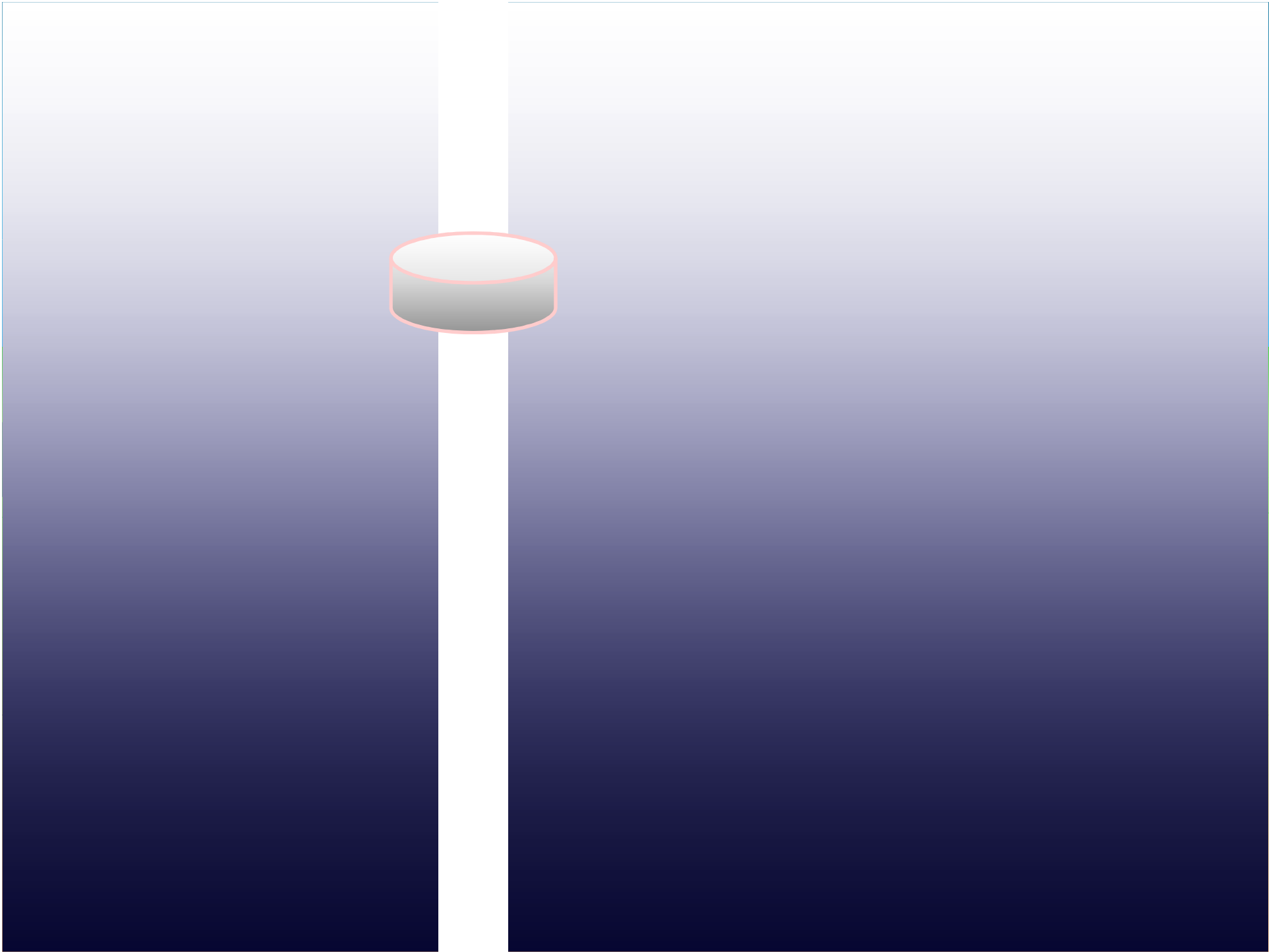

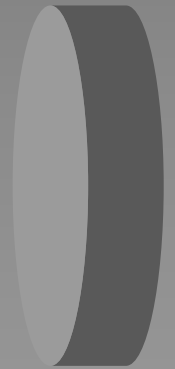
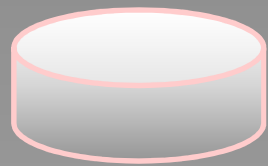

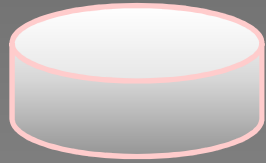

Wieder nahm ihn der Teufel mit sich und führte ihn auf einen sehr hohen Berg;

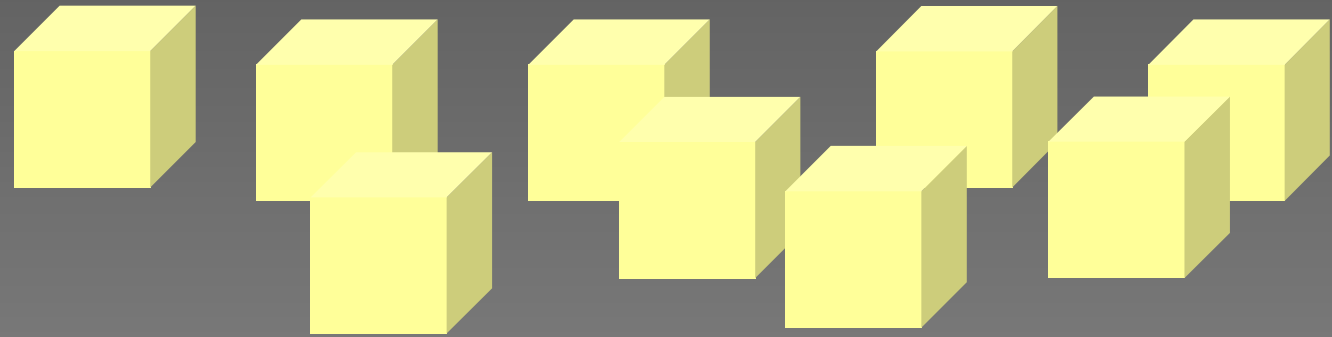
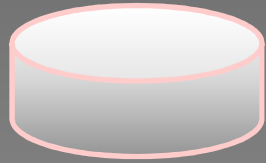

er zeigte ihm alle Reiche der Welt mit ihrer Pracht

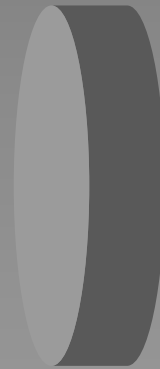
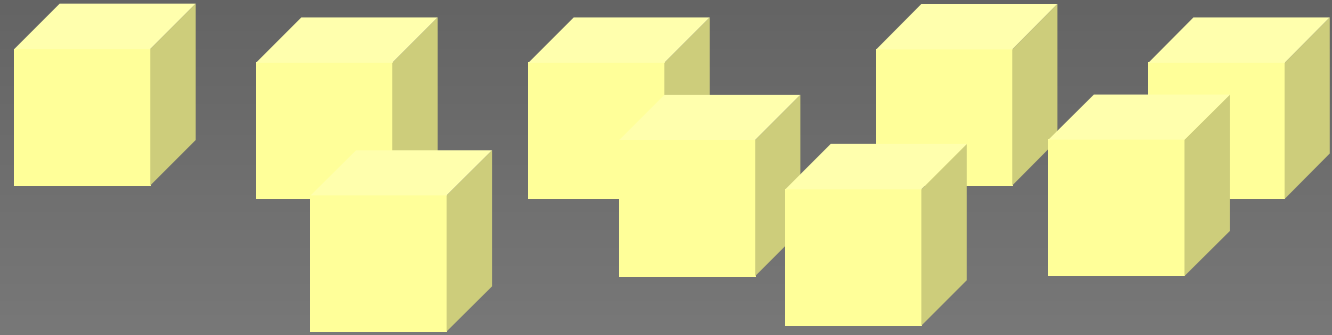
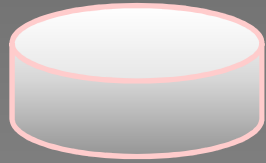

und sagte zu ihm:

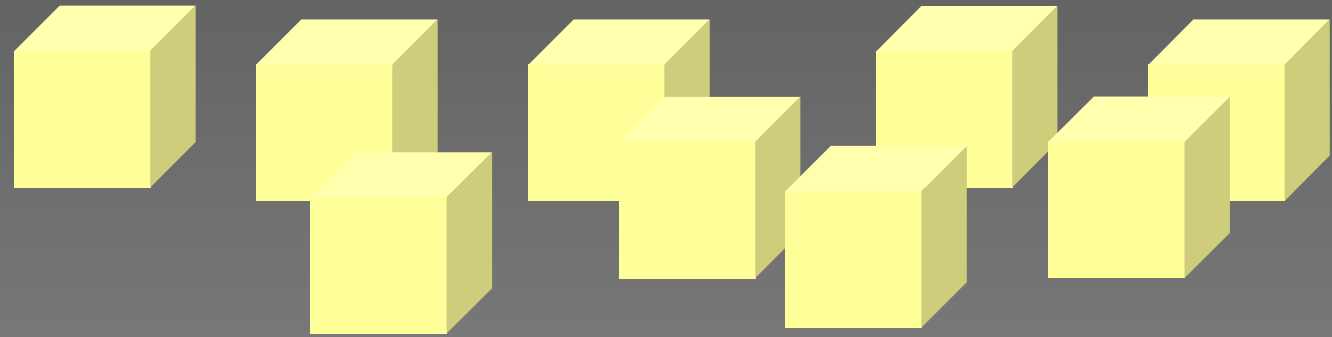
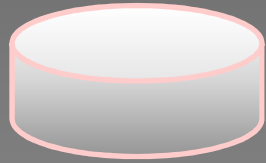

Dir will ich alle diese Macht und Herrlichkeit geben

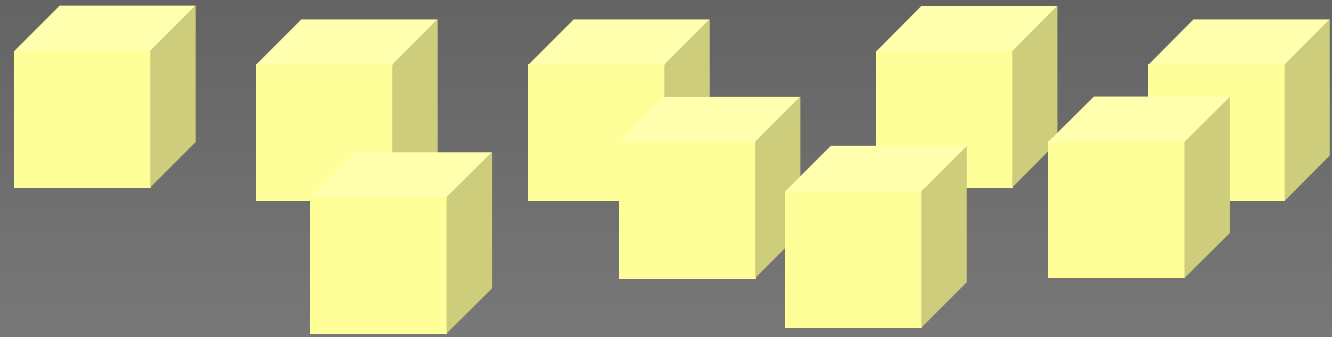
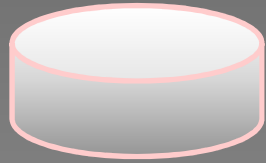

wenn du dich vor mir niederwirfst und mich anbetest.



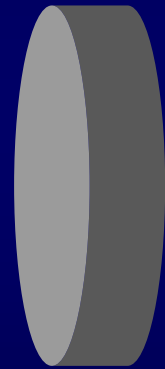
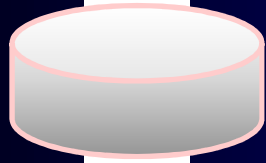

Da sagte Jesus zu ihm:

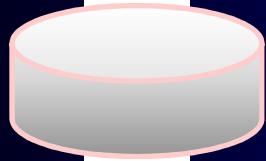

Weg mit dir, Satan!

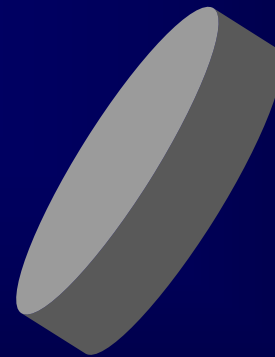
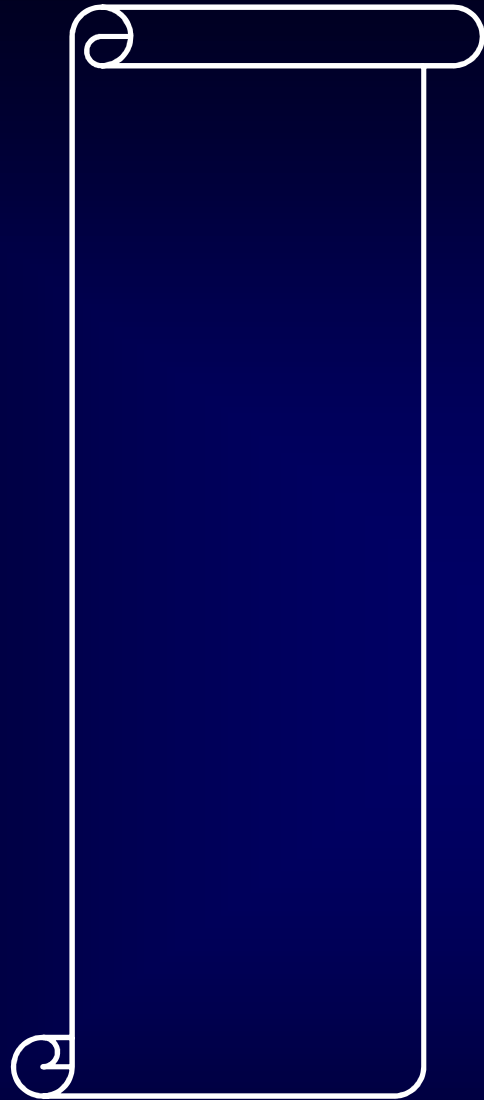
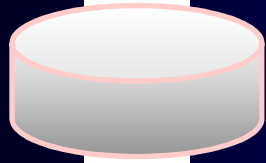

denn in der Schrift steht:

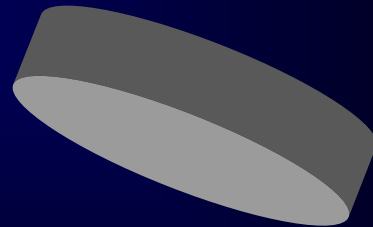
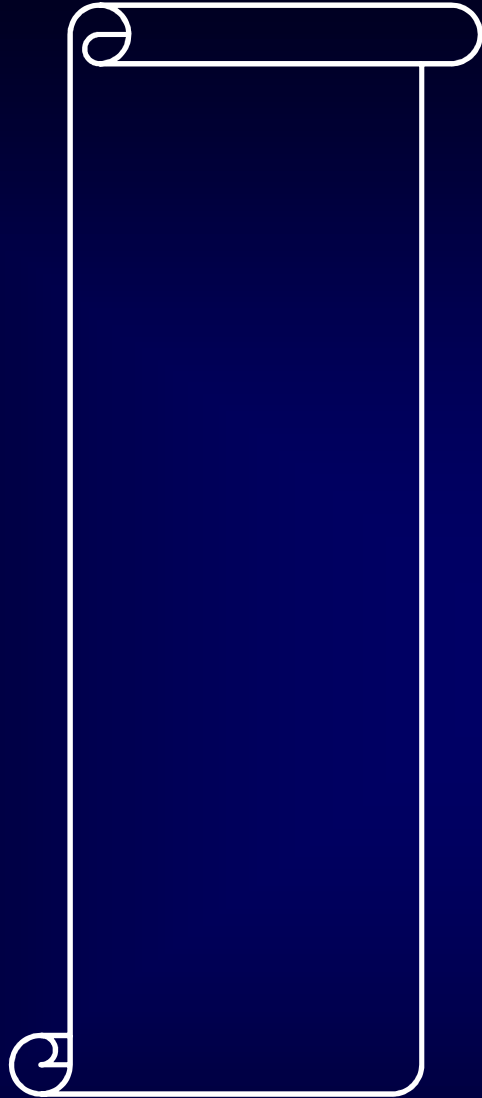
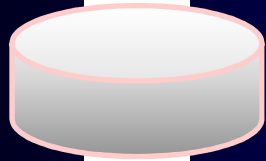

„Vor dem Herrn, deinem Gott, sollst du dich niederwerfen  
und ihm allein dienen.“

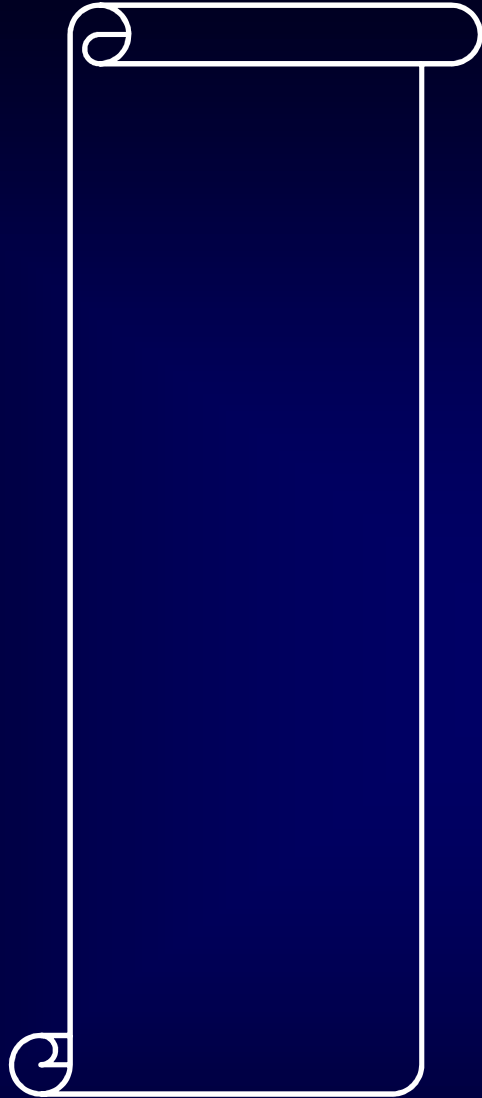
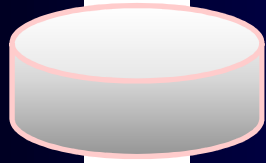

Darauf ließ der Teufel von ihm ab,



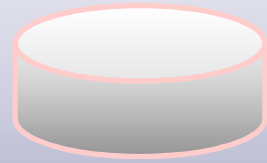

und es kamen Engel



und dienen ihm.

